



GCC LaserPro E200S User Manual



Version: 1.0
Release Jun., 2022



Release Note

Version	Release Date	Change
1.0	Jun., 2022	First version



TABLE OF CONTENTS

Chapter 1 Safety	5
1.1 Principles of a CO2 Laser	6
1.2 Safety Ratings	6
1.3 The Safety Interlock System	6
1.4 Safety Labels	6
1.5 Safety Measures	10
1.6 Operating Environment	11
1.7 Noise Test	11
Chapter 2 Unpacking	12
2.1 Unloading and Unpacking	13
Chapter 3 Mechanical Overview	16
3.1 Front View	17
3.2 Top View	17
3.3 Right (Profile) View	18
3.4 Left (Profile) View	18
3.5 Rear View	19
3.6 Water Chiller Front View	20
3.7 Water Chiller Right View	21
3.8 Water Chiller Left View	21
3.9 Water Chiller Rear View	21
Chapter 4 Machine Setup	22
4.1 Water Chiller Setup	23
4.2 E200S Machine Setup	25
Chapter 5 Software Setup	28
5.1 Recommended Computer Configuration	29
5.2 E200S Software - SmartJOB Installation	29
5.3 E200S Driver Installation	34
Chapter 6 Connection Setup	35
6.1 Machine Connection Setup	36
6.2 Computer Assigns the Connection Method	38
6.3 Connection Troubleshooting	45
Chapter 7 Operating the GCC LaserPro E200S	47
7.1 How to use focus tool	48



7.2	SmartJOB Software Operation.....	50
7.2.1	User interface introduction.....	50
7.2.2	Functional Introduction.....	50
7.2.3	Trace Image Files.....	51
7.2.4	Engraving & Cut by SmartJOB (workflow).....	54
7.3	The LaserPro E200S Print Driver.....	58
7.3.1	Page Setup and Orientation.....	58
7.3.2	Color Management.....	60
7.3.3	Using the LaserPro E200S Print Driver.....	61
7.3.4	Using the LaserPro E200S Print Driver >> Pen Page.....	62
7.4	E200S Touch Panel Operation.....	71
7.4.1	Navigation Chart of E200S Touch Panel.....	71
7.4.2	Main Work Page.....	72
7.4.3	Function Page.....	73
7.4.4	File Management Page.....	74
7.4.5	File Management Page >> File Edit Raster Page.....	74
7.4.6	File Management Page >> File Edit Vector Page.....	75
7.4.7	Machine Setting.....	76
7.4.8	Other Page >> Air Delay Setting Page.....	76
7.4.9	Offset Tuning.....	77
7.4.10	LED Light Setting.....	78
7.4.11	Reset Page.....	78
7.4.12	Machine Information Page.....	79
7.4.13	Advanced Option.....	80
7.4.14	Advanced Option >> Laser Status.....	80
7.4.15	Advanced Option >> Origin Position.....	81
Chapter 8	82
Optional Items	82
8.1	Fume Extraction System Option.....	83
8.1.1	INSTALLATION (Self-Assembled Unit).....	83
8.2	Air Compressor Option.....	84
8.3	Rotary Attachment Option.....	87
Chapter 9	93
Basic Maintenance	93
9.1	Suggested Cleaning and Maintenance Supplies.....	94



9.2 Maintaining the Worktable and Motion System	95
9.2.1 Cleaning the Worktable and Motion System	95
9.2.2 Lubrication of the X / Y Rails	96
9.3 Cleaning the Optics System	97
9.3.1 Cleaning the Mirrors	97
9.3.3 Removing and Cleaning the Focal Lens	98
Chapter 10 Appendix	100
10.1 GCC LaserPro E200S Specification sheet	101

Chapter 1

Safety

Principles of CO2 Laser

Safety Ratings

The Safety Interlock System

Safety Labels

Safety Measures

Operating Environment

1.1 Principles of a CO₂ Laser

LASER is the acronym for Light Amplification by Stimulated Emission of Radiation. A CO₂ laser works by electrically stimulating the molecules within a carbon dioxide gas mixture. When focused through a lens, this highly-intense, invisible beam will vaporize many materials. Depending on the speed and intensity of the projected beam, a CO₂ laser may be used to engrave or cut through a wide variety of materials.

1.2 Safety Ratings

The LaserPro E200S is equipped with a sealed carbon-dioxide laser that emits intense and invisible laser radiation with a wavelength of 10.6 microns in the infrared spectrum. Although the laser tube itself is classified as a Class IV laser product. The laser system is designated as a Class I laser device, meaning that the system is equipped with key safety features and an enclosed laser head to completely contain the laser under normal use. One of the key safety features found on the LaserPro E200S is a Class 2 red beam safety guidance pointer (similar to a laser-pointer presentation pen) allowing the operator to see the exact location where the laser beam will fire. Even though the LaserPro E200S is equipped with our most powerful laser to date, proper usage and hardware safeguards make it an extremely safe machine. When the front door and back door are open, machine becomes Class 4 equipment and users must wear goggles to operate the machine.

1.3 The Safety Interlock System

The laser system is equipped with a safety interlock system utilizing magnetic sensors on the top and side access doors, laser-activation and door LED lights on the control panel. The magnetic sensors will deactivate the laser when either door is opened. At this time, the "door" LED light found on the control panel will illuminate, indicating an open or improperly closed door. When the laser is in operation, the "laser" LED will illuminate to inform the operator that the laser is activated. If at any time, any of the access doors are open and the "laser" LED is illuminated, IMMEDIATELY unplugs the laser system and contact GCC technical support for service instructions.



WARNING

- DO NOT operate the laser system if any component of the safety system is malfunctioning.
- DO NOT attempt to remove or modify any component of the safety interlock system.

1.4 Safety Labels

According to CDRH standards, all fixed or removable covers that allow access to a laser beam must have the appropriate laser warning labels attached to them. These warning labels must be clearly visible to the operator prior to removing the cover. Additional labels must be applied inside of the machine and be visible in the event the covers are removed. A label clearly displaying the manufacturer's name, date of manufacture, description of product, model number, serial number, and compliance statement must be attached to the outside of the machine.

In compliance with CDRH standards, the required warning labels are affixed at the time of manufacture to the LaserPro E200S in the appropriate locations. These labels are not to be modified in any way or removed for any reason. Please familiarize yourself with the specific labels and their locations on the machine. Below is a list of all the safety labels and their locations on the machine.

Product Label

This label is located at the right-back side of machine. All the product information such as Serial Number, Model Numbers, Laser Power and Electric power can be found here. Before requiring any tech support, always provide service person the information on this label.

		Serial Number 150357
Manufacturer	Great Computer Corporation	
Product	Laser Engraver	
Model	E200S	
Model Number	E200S-40	
Wavelength	10.57-10.63 μm	
Power	CO ₂ 40W	
Input	100-240VAC, 50-60Hz, Max 15A	
Manufactured	May 2012	
Class I Laser Product Complies with EN60825-1:2014, EN ISO 13849-1:2015 Class II Laser Product Complies with CDRH Made in Taiwan 4F-1., No.236, Fude 2nd Rd., Xizhi Dist., New Taipei City 22151, Taiwan		
		

Safety Label

CDRH and CE regulations require that all laser manufacturers add warning labels in specific locations throughout the equipment. The following warning labels are placed on the laser system for your safety. Do not remove these labels for any reason. If the labels become damaged or have been removed for any reason, do not operate the laser system and immediately contact Great Computer Cooperation or e-mail us for a replacement.

Door open warning labels



CDRH Label

This label indicates the class level of CDRH.



CE Label

This label identifies the classification of the Model in accordance with IEC 60825-1. It is located on the rear of the machine's cabinet.



Aperture warning stickers (mirror):

This label indicates the laser path. Normally you can find this label inside of machine or laser exit. Please take extra caution of this area when you conduct maintenance or operate machine.

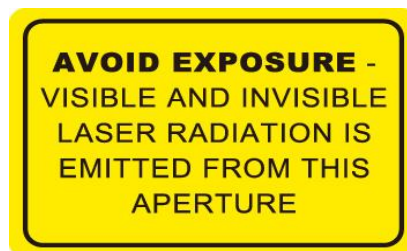

Aperture warning stickers

DANGEROUS VOLTAGES ARE PRESENT WITHIN THE ELECTRONICS ENCLOSURES OF THIS SYSTEM. Access to these areas is not necessary during normal operation. If it becomes necessary to open one of these enclosures for service reasons, please remember to disconnect the power cord from your electrical supply.



Warning Label

Warning Label is written with all the necessary information to be aware of during operation.

Invisible laser radiation when door open and interlock failed.

Avoid eye or skin exposure direct to laser radiation.

Do not leave the machine unattended during operation.

Please clean the bearings and motion system tracks every day.

Do not use reflective metals, heat sensitive surface or materials that may produce toxic substances or corrosion problems, such as PVC and Teflon.



Laser Path Warning Label

LaserPro machines are very safe under normal use. Furthermore, Laser Path Warning Labels are displayed at the proximities of possible laser paths as a reminder. Operators should exercise caution when working close to these laser paths to avoid possible injury while machine is turned on.



Laser Path Danger label

This label indicates the laser path. Normally you can find this label inside of machine. Please be very careful of this area when you do the maintenance.

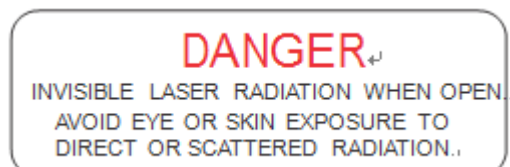

1.5 Safety Measures

- **LASER RADIATION WARNING:** Exposure to laser radiation may result in physical burns and severe eye damage. Proper use and regular maintenance of this machine is important to the safety of all people in the immediate area.
- Prior to operation, carefully read and familiarize yourself with the warning labels located on both your laser system and in this manual.
- Never leave the machine unattended during the laser cutting and engraving process. The laser may ignite combustible materials. A well-maintained fire extinguisher and operational smoke or fire detector should be kept in the vicinity of the machine.
- **Caution—Use of controls or adjustments or performance of procedures other than those specified herein may result in hazardous radiation exposure.**
- GCC cannot be held responsible for any direct or indirect damages, which result from using or working with the products electric circuits or software described herein. The apparatus must be used only by trained and skilled personnel. Before using the machine, user should read and follow the manuals carefully. Furthermore GCC reserves the right to change or alter any product described herein without prior notice.
- Resulting debris from laser cutting are very dangerous and may cause fire hazard.
- **DO NOT** leave debris and scraps inside laser machine after job finished. Must keep machine clean after job finished.



WARNING

- Resulting debris from laser processing are very dangerous and may cause fire hazard
- **DO NOT** leave debris and scraps inside laser machine after job finished. Must keep machine clean after job finished.
- Always remove the vector grid or honeycomb table to clean any small pieces that have fallen through the grid.

NOTE

Each LaserPro laser machine is shipped with a single pair of safety goggles. If additional safety goggles are required, please contact GCC directly or an authorized GCC distributor. If you wish to purchase one on your own, please make sure the safety goggles meet these requirements:

**9000-11000nm OD5+
Visible Light Transmission: 92.9%**

- Connect the machine to a properly grounded power outlet. Ensure the voltage of the power source is identical to the voltage of the machine.
- Do not open the laser access panel when the machine is plugged in.
- Do not attempt to modify or disassemble the laser module.
- Do not attempt to remove or modify any component of the machine's laser interlock safety system.
- Ensure the immediate work area of the machine is well-ventilated. Odors, vapors, and dust are by products generated during the laser engraving and cutting process. An exhaust system, vacuum cutting box, and honeycomb table are recommended. Please contact GCC or your local GCC distributor for more information.
- Do not laser heat-sensitive surfaces or materials that may generate toxic fumes, such as PVC and Teflon
- Regularly clean and maintain your machine according to our cleaning and maintenance instructions. Doing so will ensure a machine that will operate effectively and safely over a long period of time.

1.6 Operating Environment

Please follow the guidelines when considering a suitable location to set the LaserPro E200S. Improper work environments may lead to operational malfunction and/or unsafe working conditions. The LaserPro E200S should be placed and operated in a standard office-type environment.

- Avoid environments where the machine is exposed to high levels of dust, temperature (temperatures exceeding 30°C or 85°F) or humidity (humidity exceeding 70% or where the ambient temperature is near the dew point).
- Avoid small, enclosed areas with poor ventilation.
- Avoid areas with high levels of noise and electrical noise.
- Select a location that is large enough to accommodate the LaserPro E200S, an exhaust system, a computer and a work or storage table.
- Select a location in which the ambient temperature remains between 15°C and 30°C (60°F to 85°F).
- Select a location in which the relative humidity remains between 30% - 40%.
- Select a location in which there is a short, direct path to the fume exhaust system.
- Set the LaserPro E200S on a floor surface that is completely even.
- Make sure your smoke or fire detection system in the immediate area is functioning.
- Setup the machine to be at least 60 cm (2 feet) away from the wall.

1.7 Noise Test

Test Conditions: measured at a distance of 1 meter from the surface of the machinery and a height of 1.6 meters from the floor or access platform.

- E200S 40W Sound Test Result: 68.4 dB

Chapter 2

Unpacking

Unloading & Unpacking

2.1 Unloading and Unpacking

The GCC LaserPro E200S is shipped in one crate that contains machine, software, and all of the necessary accessories. The following section shows detailed step-by-step instructions for unpacking and assembly the accessory to workstation.

WARNING

More than one person may be needed when loading and unloading the shipping crate in order to avoid body injury or damage to the machine.

NOTE

Please keep and store the original shipping crate in case it is needed for future transportation or product servicing.

- 1) Move the shipping crate to the proximity of the designated work area.

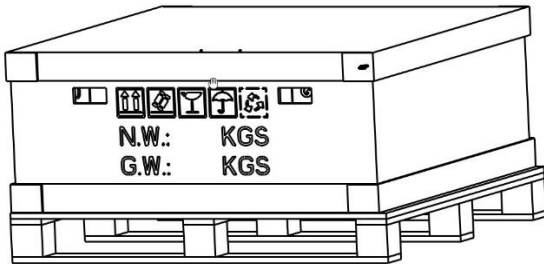

- 2) Remove the top cover carton.

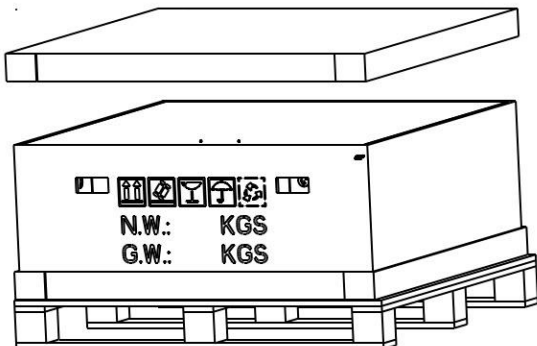

- 3) Remove the packing foam on the top.

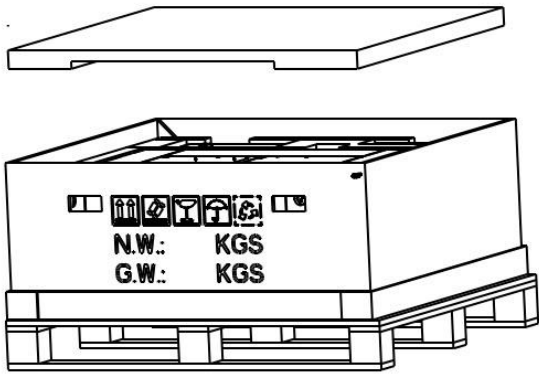

- 4) Remove the side-cover carton.

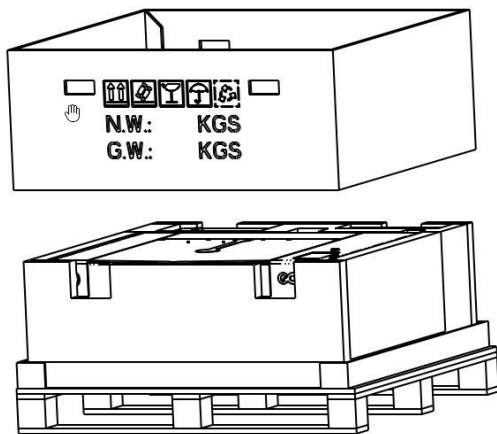

- 5) Release the four safety blocks that hold the machine in place.

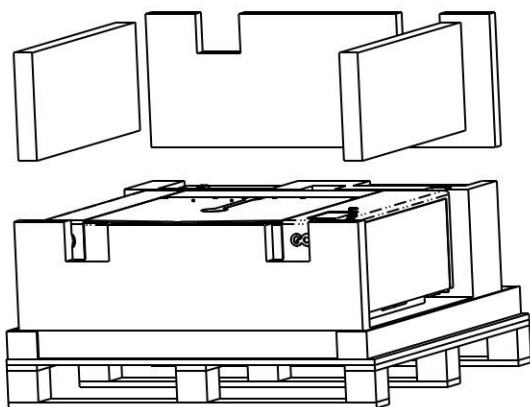

6) Take out the water chiller and the accessory box.

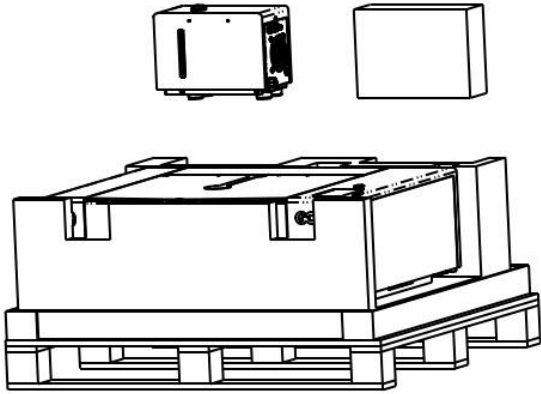

7) Now you can take out the machine.

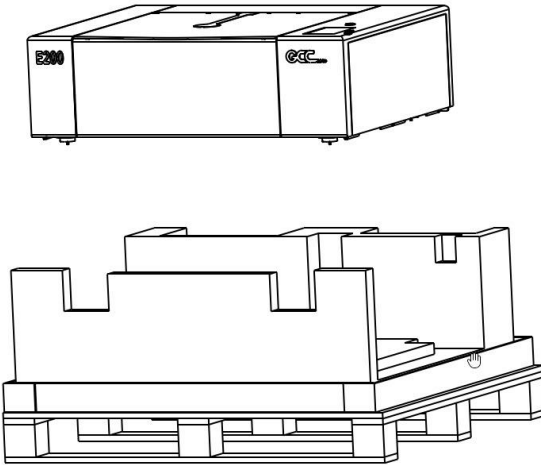

8) Lastly take out the laser materials which we enclose within E200S.

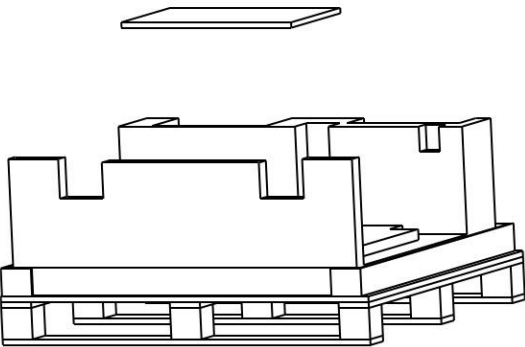

Chapter 3

Mechanical Overview

[Front View](#)

[Right View](#)

[Left View](#)

[Rear View](#)

[Water Chiller Front View](#)

[Water Chiller Right View](#)

[Water Chiller Left View](#)

[Water Chiller Rear View](#)

Please take some time to familiarize yourself with this section regarding the mechanical overview of the LaserPro E200S. References will be made back to the different parts of the LaserPro E200S in later sections.

3.1 Front View

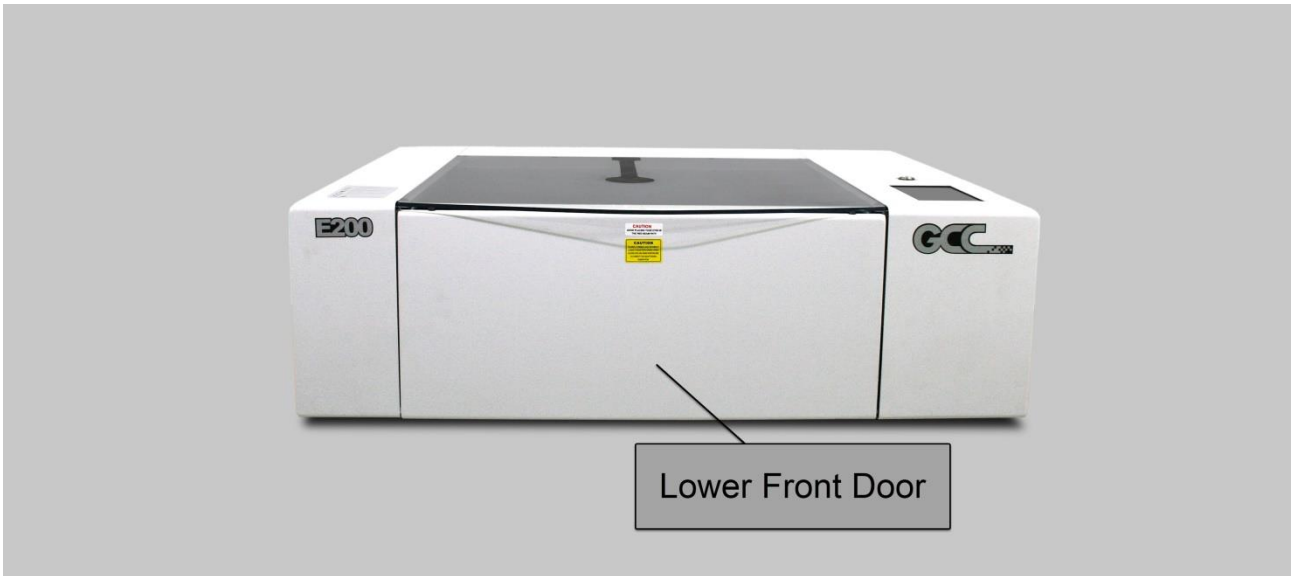

3.2 Top View

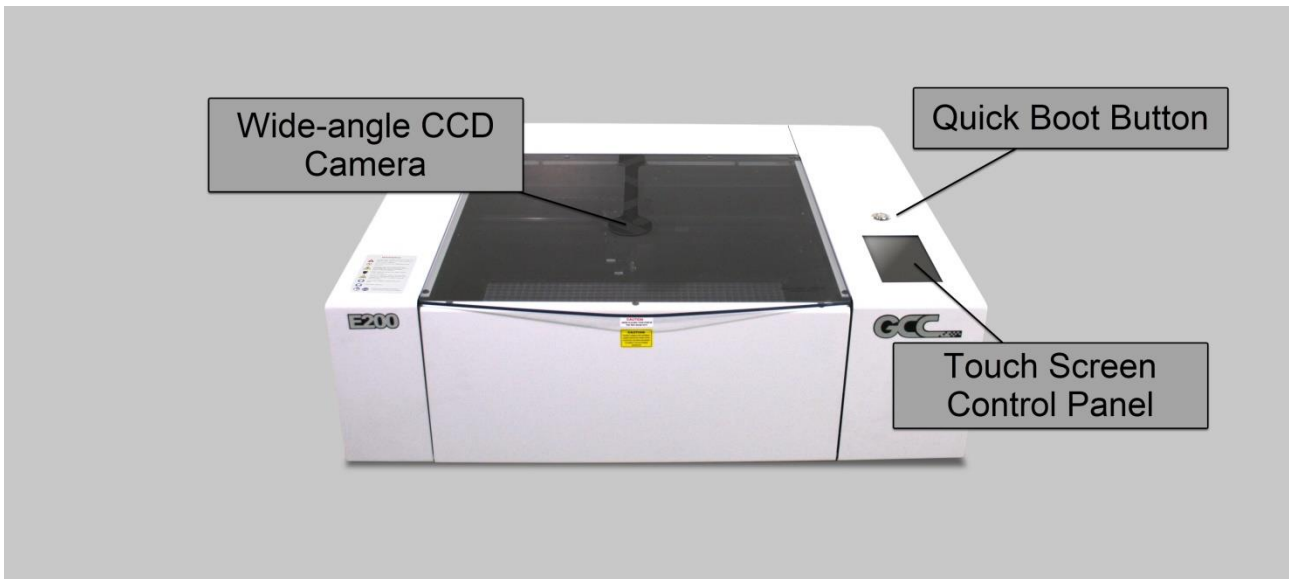

3.3 Right (Profile) View

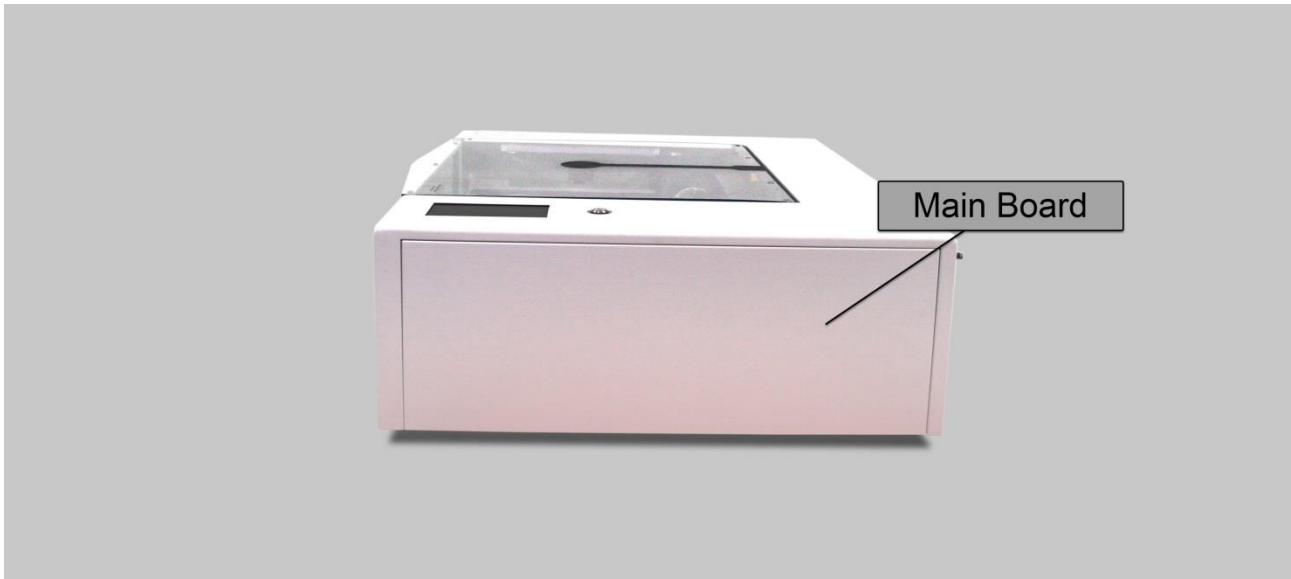

3.4 Left (Profile) View



3.5 Rear View

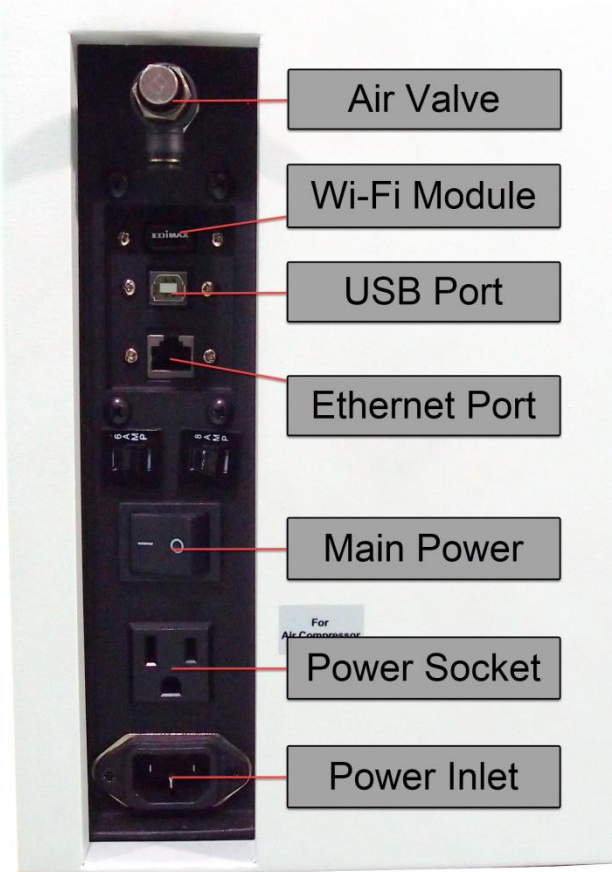

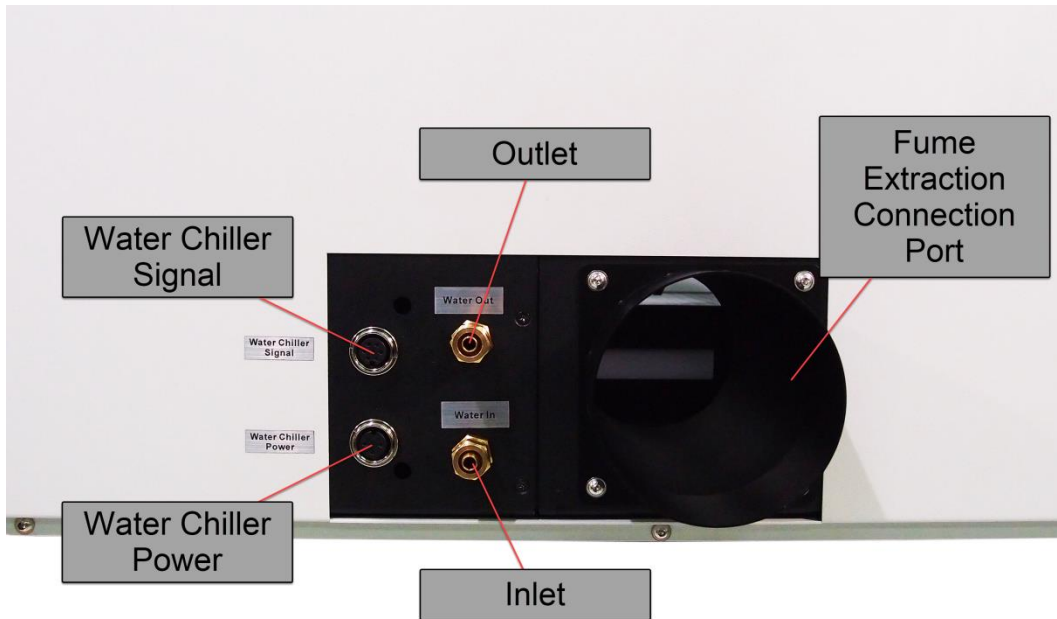

3.6 Water Chiller Front View



3.7 Water Chiller Right View



3.8 Water Chiller Left View

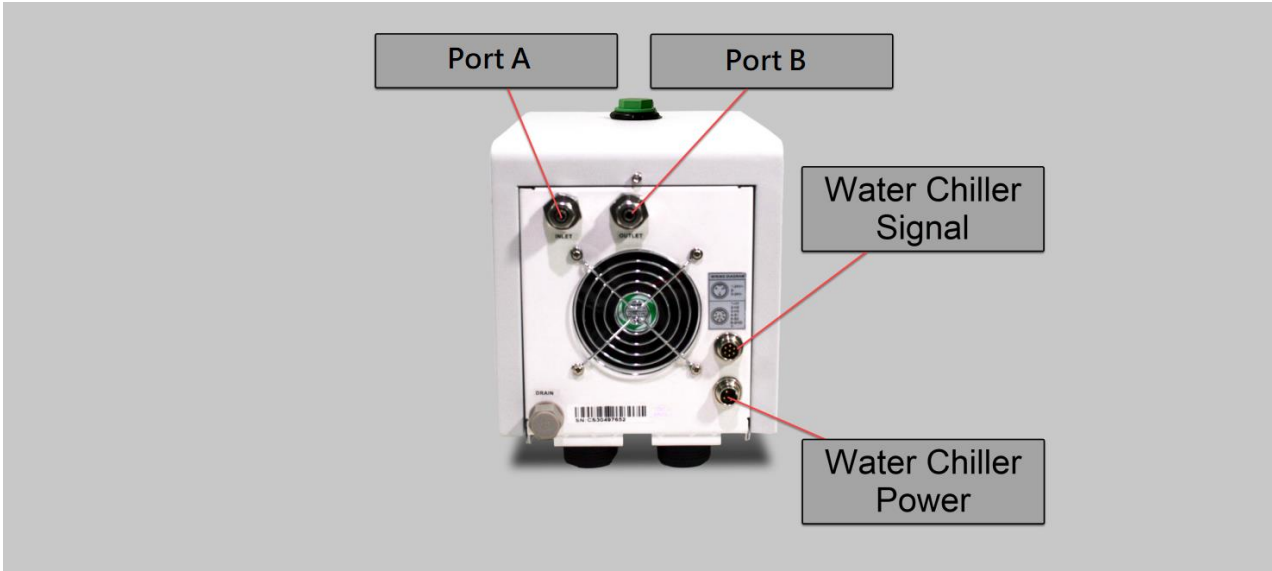

3.9 Water Chiller Rear View

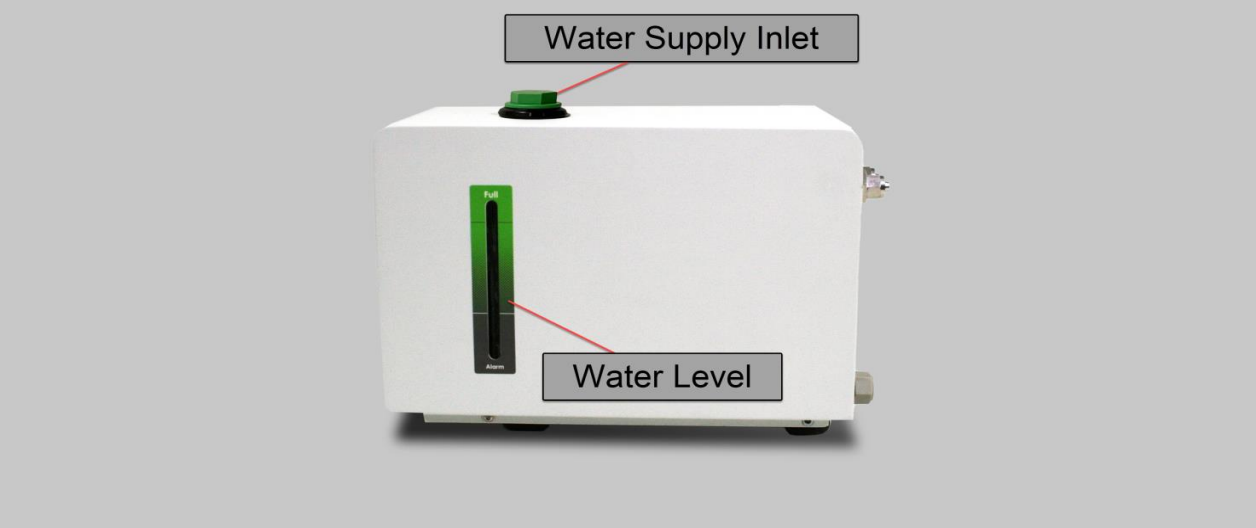

Chapter **4**

Machine Setup

Water Chiller Setup

E200S Desktop Laser Engraver Setup

4.1 Water Chiller Setup

1) Find two cables & two water hoses from the accessory box.



2) Connect the power cable from the machine to the water chiller.



3) Connect the signal cable from the machine to the water chiller.



4) Connect the water hose from the machine to the water chiller.

a. E200S machine "Port A" to water chiller "Port A".

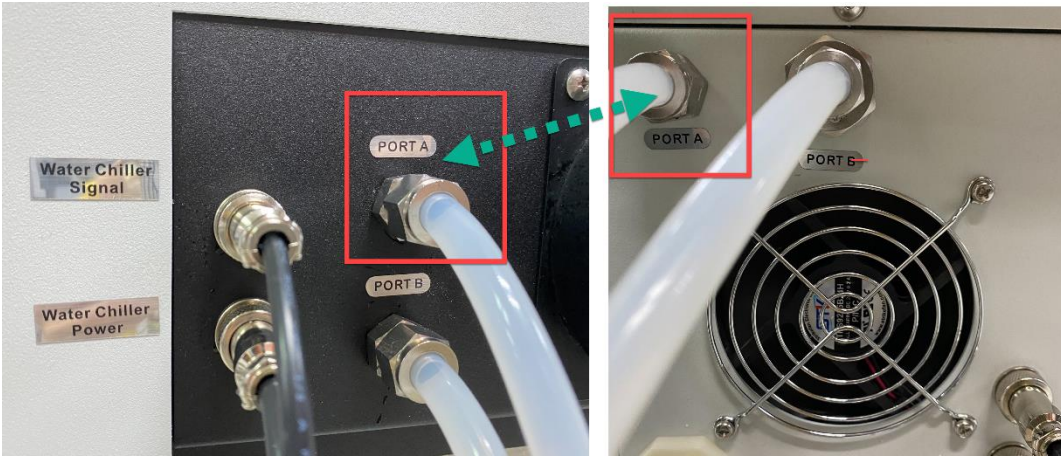

b. E200S machine "Port B" to water chiller "Port B"

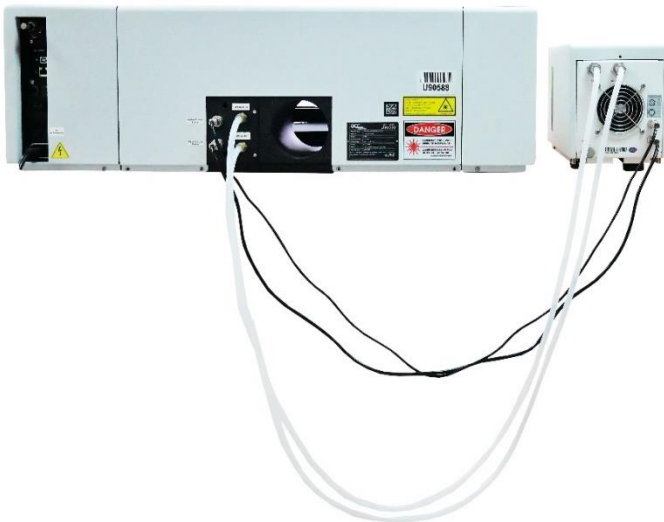
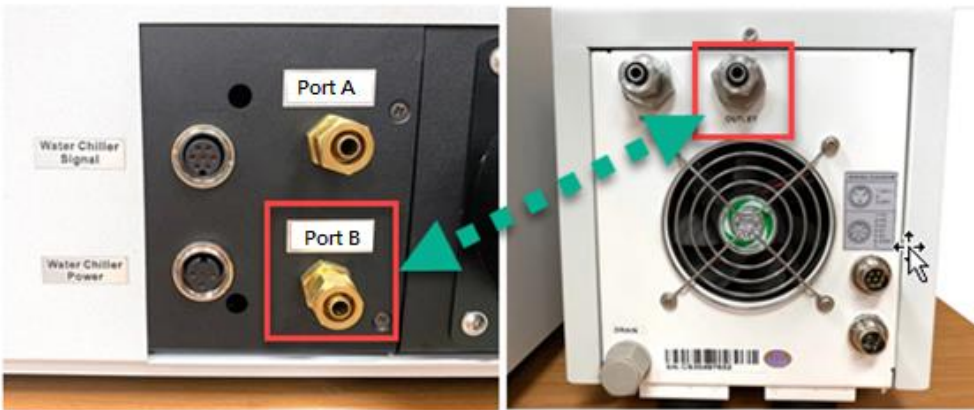

- 5) Fill distilled water into water supply inlet, make the water level be between the max and min limitation line. The tank capacity is 2L.

NOTE: Please use distilled water ONLY



- 6) E200S Water Chiller setting up is completed.

4.2 E200S Machine Setup

1. Take out the wifi dongle from the zip bag in the accessory box.



2. Insert the wifi dongle to the USB port on the back of E200S machine.



3. Connect the power cable and power on E200S machine.

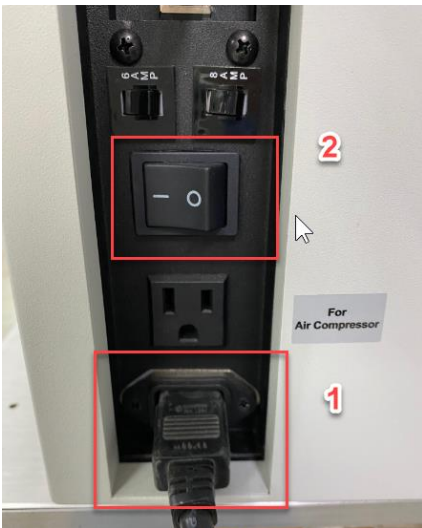

4. Press on the "Quick Boot Button" on the front of machine.



5. Remove the Camera Cover to let the camera is ready to capture the table.

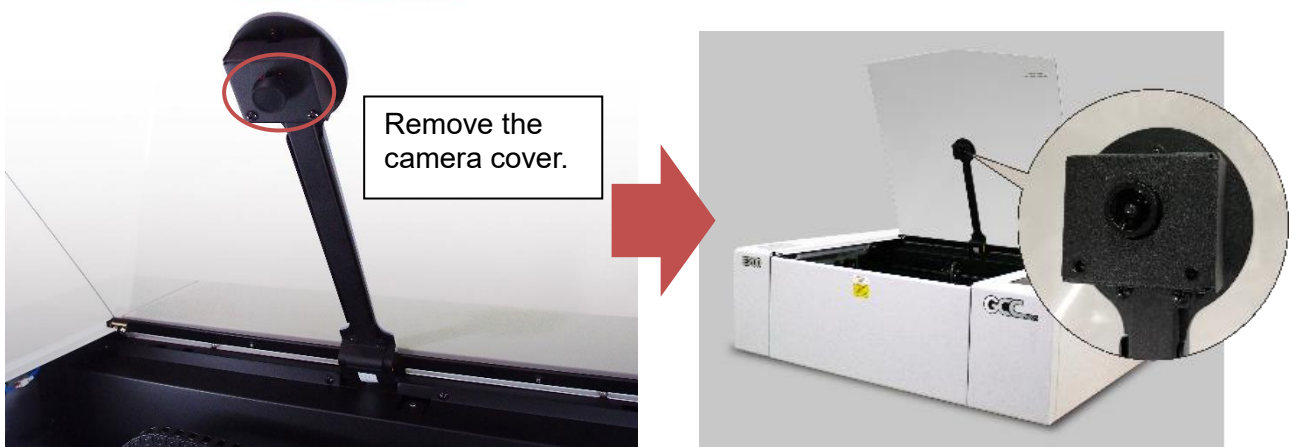

6. E200S setting up is simply and easy.

* To use the extra facility, the power voltage shall be the same as the main power.

Chapter 5

Software Setup

Recommended Computer Configuration

SmartJOB E200S Installation

E200S Driver Installation

5.1 Recommended Computer Configuration

SmartJOB E200S software was designed to work best using both Windows and MAC system with the following minimum requirements

Computer Configuration

CPU	Intel Pentium, 1GHz or above
DRAM	1GB RAM or above
CDROM	One CD-ROM disk drive
HDD	1 GB of free hard drive space
SVGA	Super VGA display (1204 x 768 min. resolution)
Interface	PC or Laptop, USB 3.0 x 2
Operating System	MS Windows, MAC OSX 10.6-10.15**

5.2 E200S Software - SmartJOB Installation

Install E200S software - SmartJOB, please click the following link to download files.

<https://www.gccworld.com/download.php?sid=software>

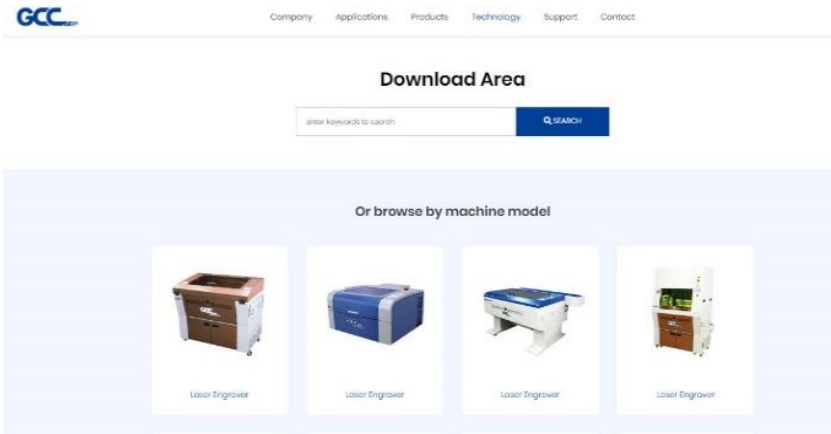

1) Click on “E200S – SmartJOB software” from the menu of the download page.

2) Click “Next”

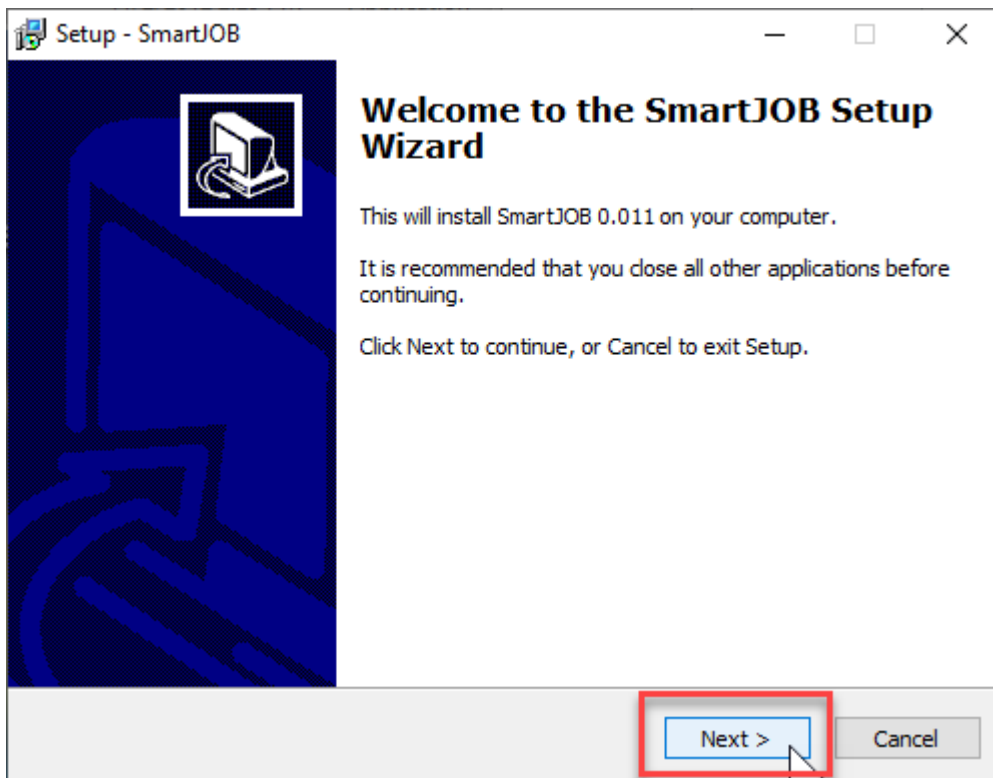

- 3) Click "Launch SmartJOB", and click Finish.

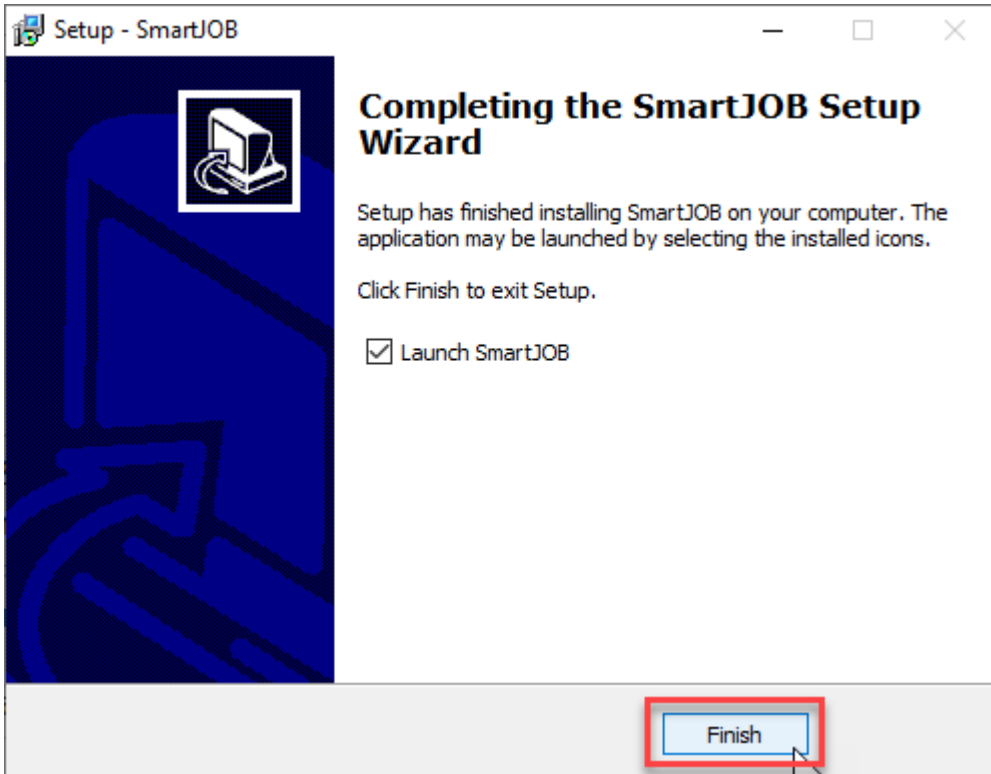

- 4) The SmartJOB will automatically open when installation is finished.



- 5) Take out the Notification from accessory box.



6) Go to "Help" --> "Activate" from the menu bar and key in name and activate code to activate the software.

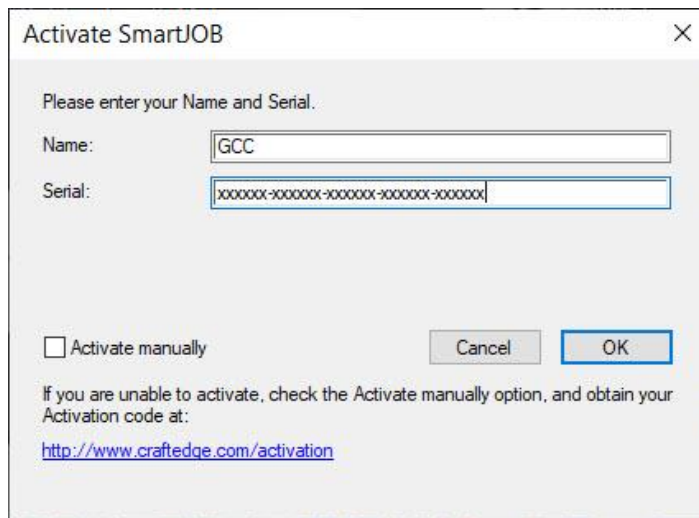

7) E200S Camera Scaling

In some cases you may find a slight output inaccuracy in the actual output compared to what you have set in the computer. This margin of error or offset is extremely small (approximately 1/300). What this means that there may be a 1-unit offset for every 300 unit increments. As an example, if you engrave a 300 mm straight line, it may end up measuring only 299 mm or 301 mm in the final output. In this case, you will want to set the scaling setting to +1 / 1000 or -1 / 1000, respectively to compensate. A general rule of thumb is for every 300 unit increment, you will want to adjust the slider by +1 if the final output is 1 unit increment shorter or -1 if the final output is 1 unit increment longer than your graphic design setting.

So before E200S delivery, we will adjust the Camera Scaling for each machine. Every machine will have its scaling number to enter to SmartJOB. The number is shown as below:

a. Please open the top lid and pull down the front door.



b. Then you will see the Camera Adjustment, please enter Width for example – 1.0000 and Height: 0.9997 to SmartJOB



C. Open SmartJOB, go to "Setting" to enter the number as below picture:

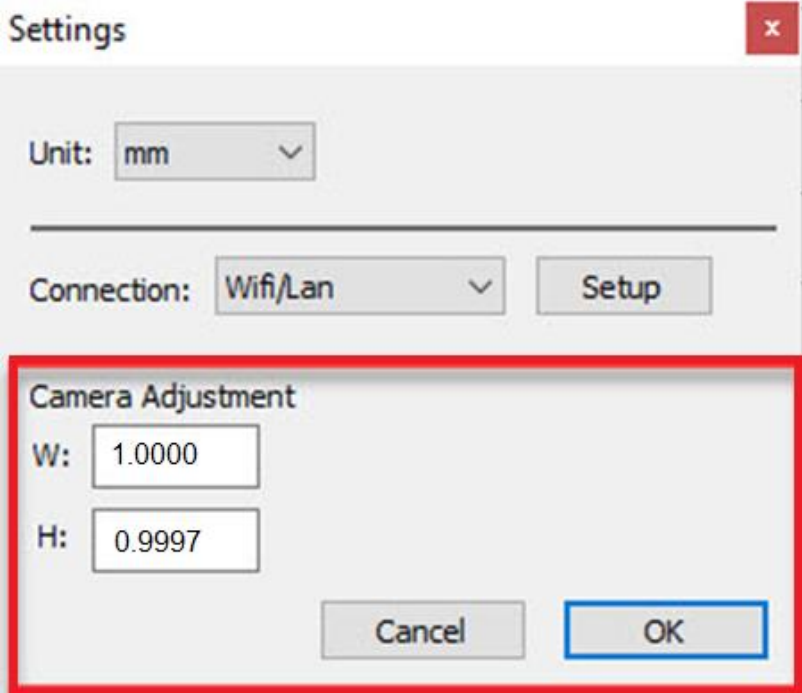

5.3 E200S Driver Installation

Please visit GCC website – download area to download E200S Print Driver and User Manual.

<https://www.gccworld.com/download.php?sid=driver>

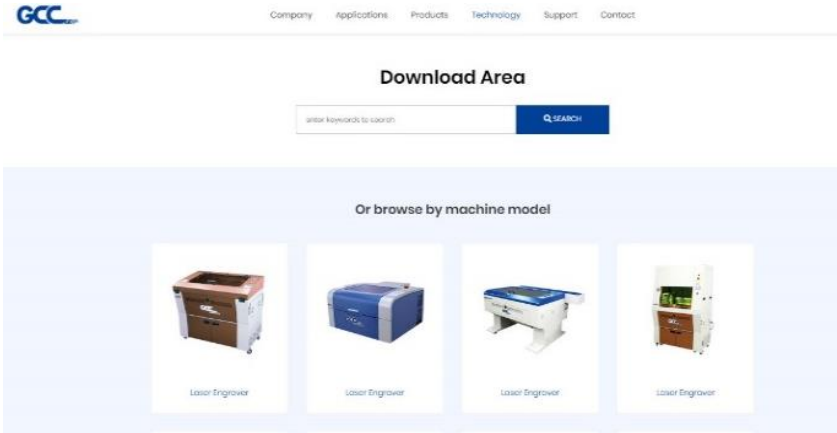

Chapter **6**

Connection Setup

Machine Connection Setup

Computer Assign the Connection Method

Connection Troubleshooting

6.1 Machine Connection Setup

The LaserPro E200S can communicate with a computer through a Wi-Fi, USB Port or LAN Port connection interface. Please see below steps for each connection method.

6.1.1 Wi-Fi Connectivity

Setting on E200S by Wi-Fi connectivity, please download the small app - E200S Connection Wizard from GCC download area <https://www.gccworld.com/download.php?sid=other>

- 1) Connect E200S with your computer by the USB cable.
- 2) Power on the turn on the machine.
NOTE: E200S has been designed to automatically switch from 100-240VAC.
- 3) Open GCC E200S Connection Wizard and click "Scan", Device "E200S" will be de detected automatically

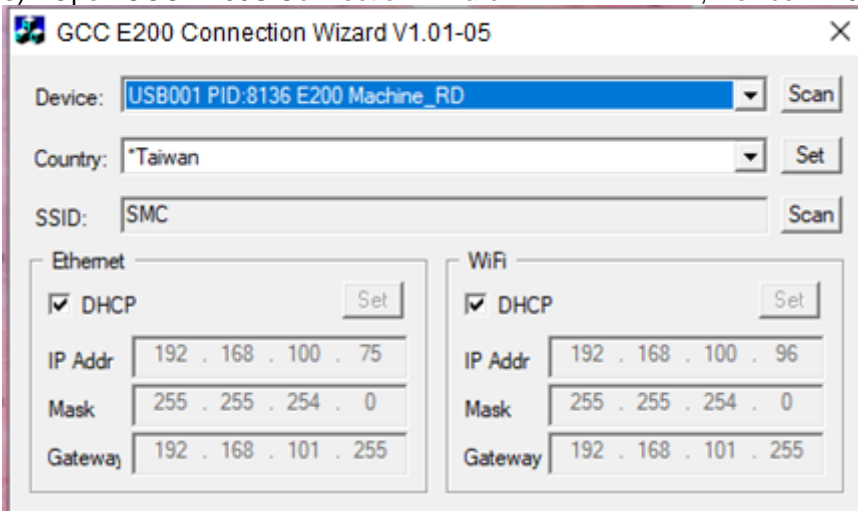

- 4) Select your country and then press "SSID- Scan" to set up available domain.



5) Choose the WiFi connection.

Dialog

SSID	MODE	CHAN	RATE	SIGNAL	SECURITY
* D-Link_DIR-809	Infra	10	54 Mbit/s	75	-
BUFFALO-8DF0BC	Infra	1	54 Mbit/s	45	-
BUFFALO-8DF0BC-1	Infra	1	54 Mbit/s	45	-
TP-LINK_8547F8	Infra	3	54 Mbit/s	45	WPA1 WPA2
SMC	Infra	6	54 Mbit/s	45	-
SMC	Infra	6	54 Mbit/s	30	-
TP-LINK_E200	Infra	10	54 Mbit/s	30	WPA2
SystemRoom	Infra	11	54 Mbit/s	30	WEP
DIR_605	Infra	11	54 Mbit/s	30	WPA1 WPA2
GCC-SE	Infra	11	54 Mbit/s	17	WEP

SSID	MODE	CHAN	RATE	SIGNAL	SECURITY
* D-Link_DIR-809	Infra	10	54 Mbit/s	75	-
BUFFALO-8DF0BC	Infra	1	54 Mbit/s	45	-
BUFFALO-8DF0BC-1					-
TP-LINK_8547F8					WPA1 WPA2
SMC					-
SMC					-
TP-LINK_E200					WPA2
SystemRoom					WEP
DIR_605					WPA1 WPA2
GCC-SE					WEP

Connect

Connect to 'SMC'

Delete Connect

GCC E200 Connection Wizard V1.01-05

Device: USB001 PID:8136 E200 Machine_RD [Scan]

Country: *Taiwan [Set]

SSID: D-Link_DIR-809 [Scan]

Ethernet

DHCP [Set]

IP Addr: 0 . 0 . 0 . 0 | IP Addr: 192 . 168 . 0 . 101

Mask: 0 . 0 . 0 . 0 | Mask: 255 . 255 . 255 . 0

Gateway: 0 . 0 . 0 . 0 | Gateway: 192 . 168 . 0 . 255

Waiting

Connect to 'SMC'..... 12

6) WiFi Setting is complete.

6.1.2 Ethernet Connectivity

- 1) Connect Ethernet cable between router and machine.
- 2) Turn ON machine.
- 3) Connect computer to Internet through Ethernet or Wi-Fi

6.1.3 USB Connection

- 1) Connect USB cable between machine and computer.

6.2 Computer Assigns the Connection Method

6.2.1 For SmartJOB

Wi-Fi / LAN

- 1) Make sure your computer is connected to the same WiFi (SMC) as E200S does

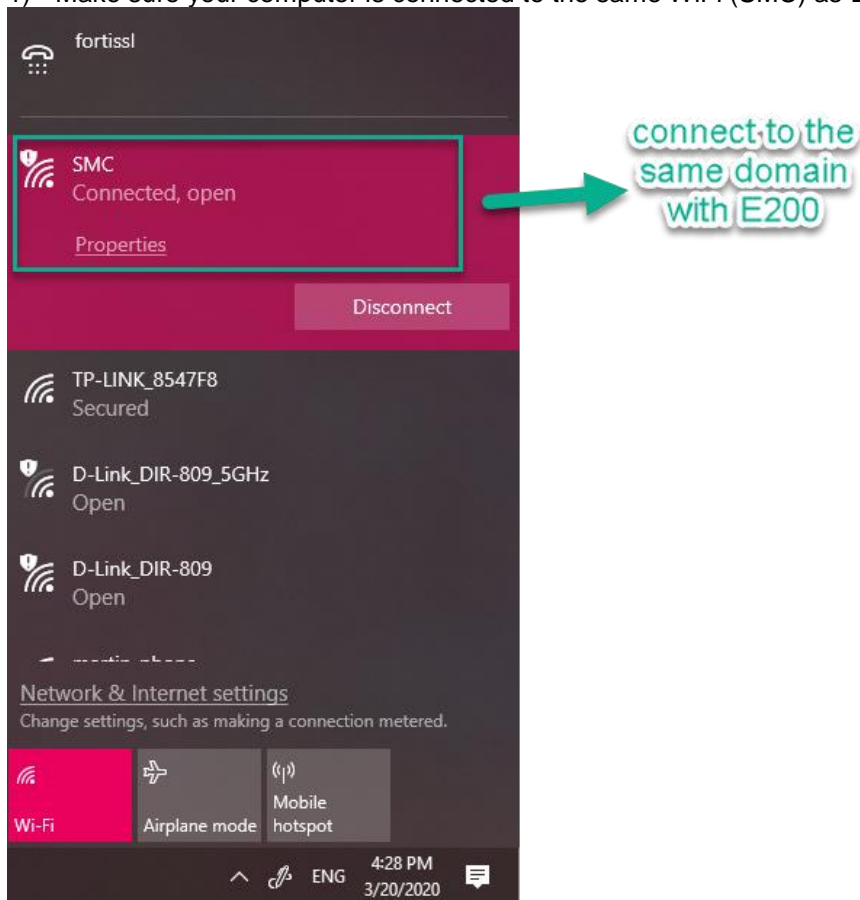

- 2) Open the SamrtJOB.

- 3) Click "Setting" on the tool bar



4) Select the “Wi-fi / LAN” on the drop-down menu of Connection

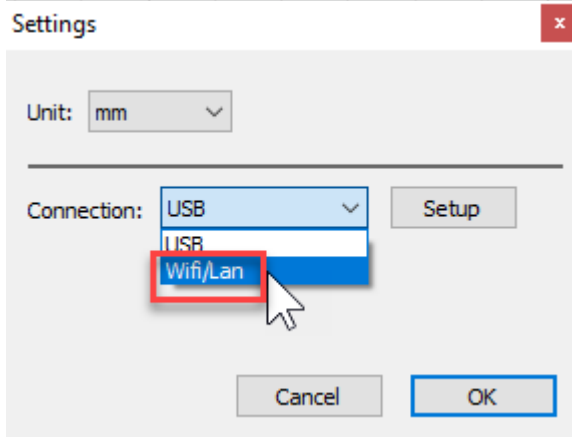

5) Click on “Setup” button to open the setup window

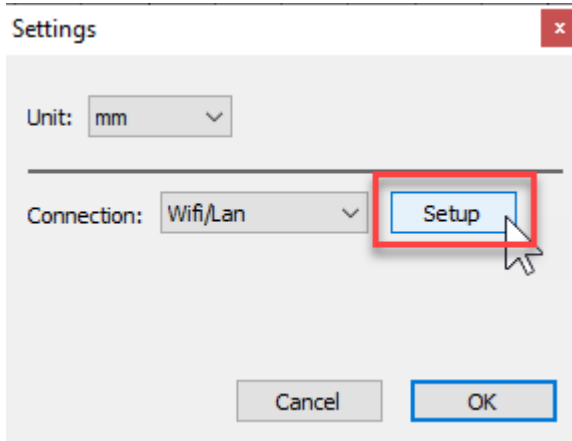

6) Click the “Scan Device” button, the software will search and show the list automatically.

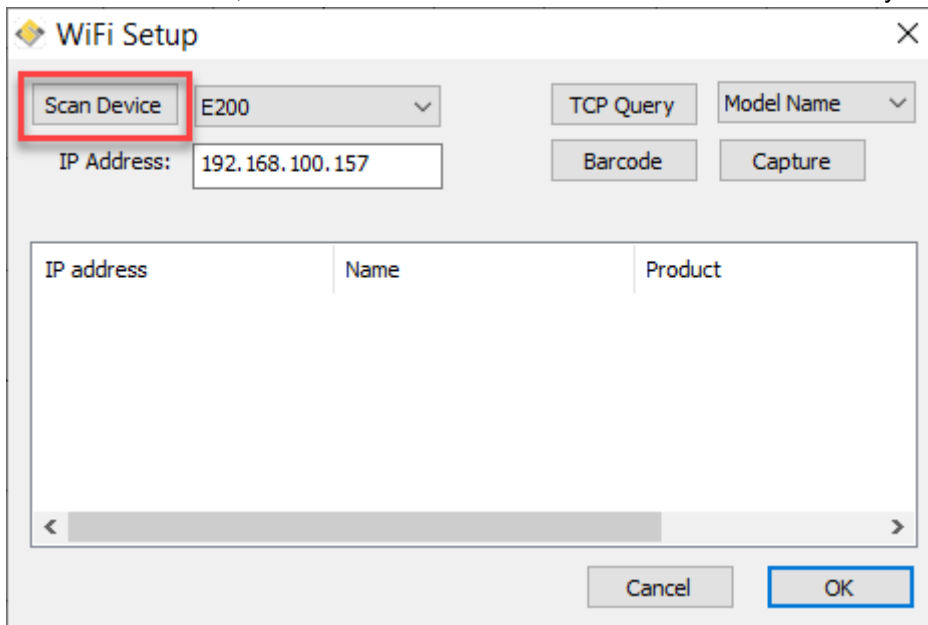

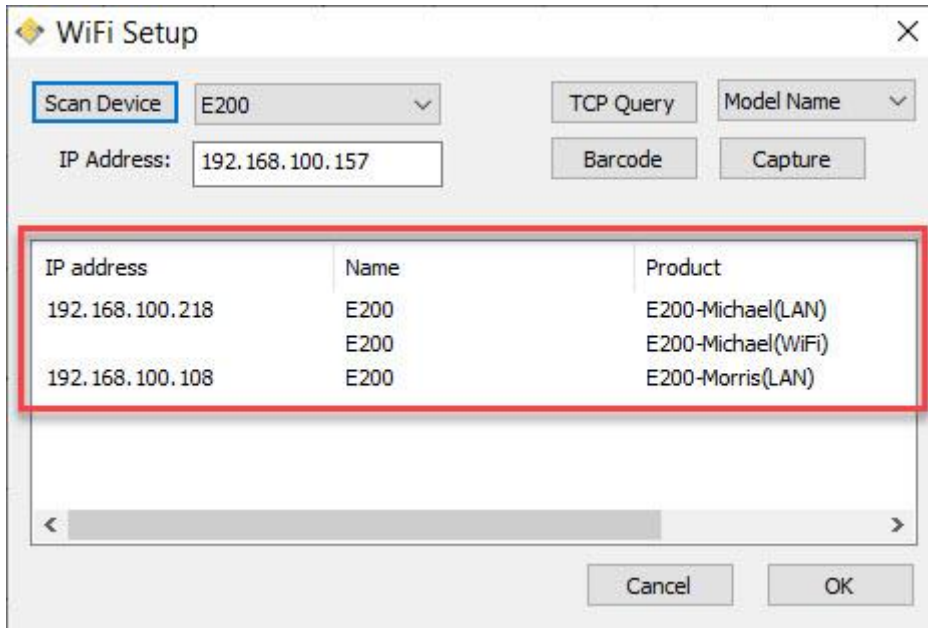

7) Click the machine you want to connect and click "OK" button.

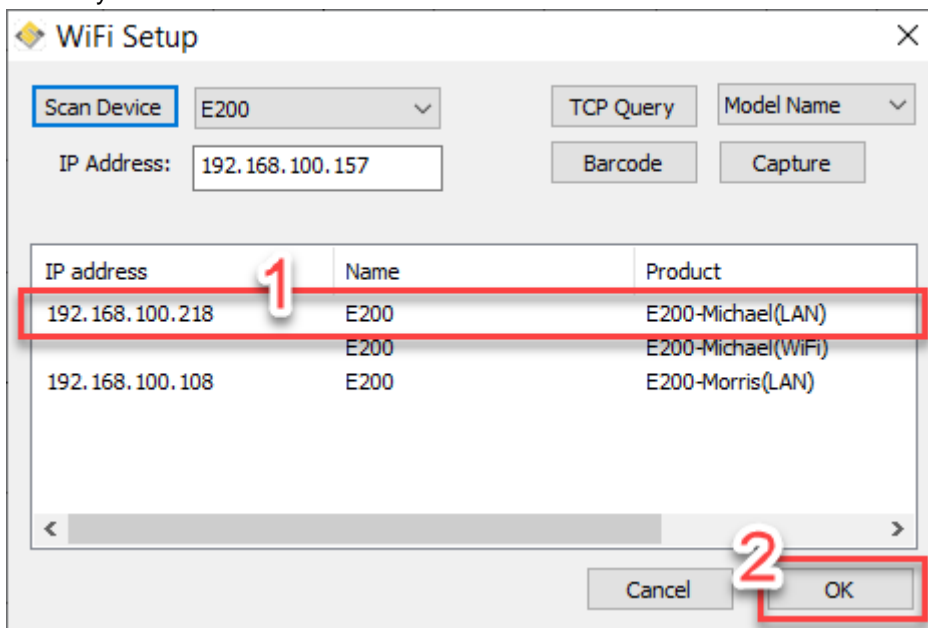

8) Wi-Fi/LAN Connection setting is completed.

USB

1) Open SmartJOB, and go to "settings" on the menu bar

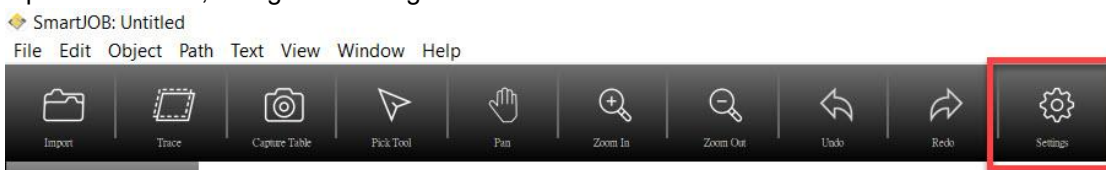

2) Select "USB" button and click "OK" button to open the setting window.

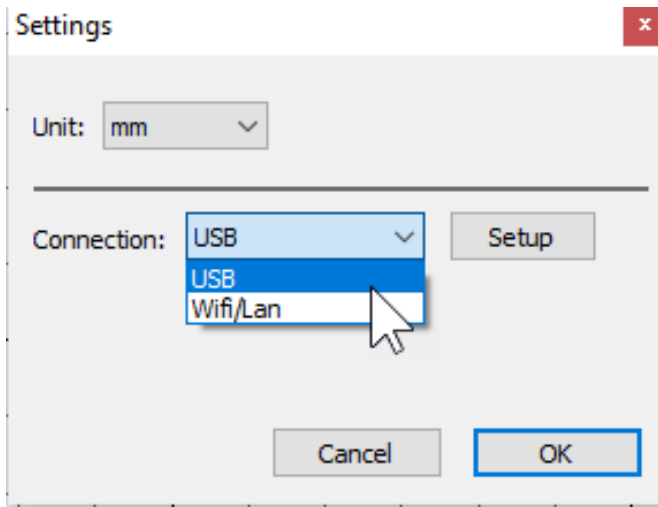

3) USB Connection setting is completed.

6.2.2 For E200S Print Driver

Wi-Fi / LAN

1) Go to "Control panel" → "Devices and Printers"

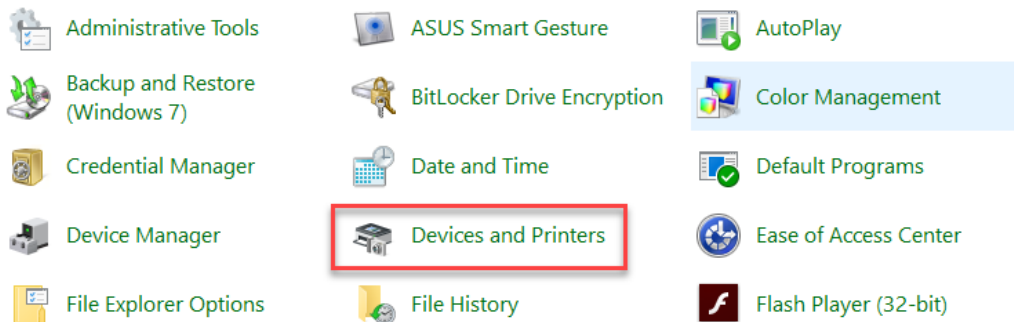

2) Double click "E200S" printer driver to open the printer driver window



3) Click "Printer" → "Properties" on the menu bar to open the properties window.

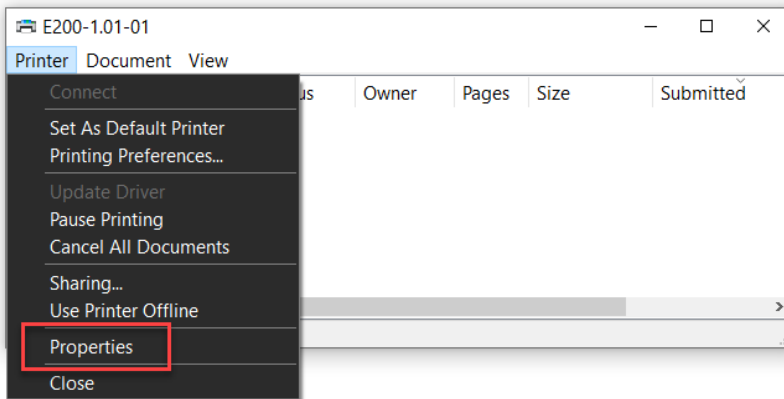

4) Click the "Pen" tab and click "Port" button to open the Port Configure window

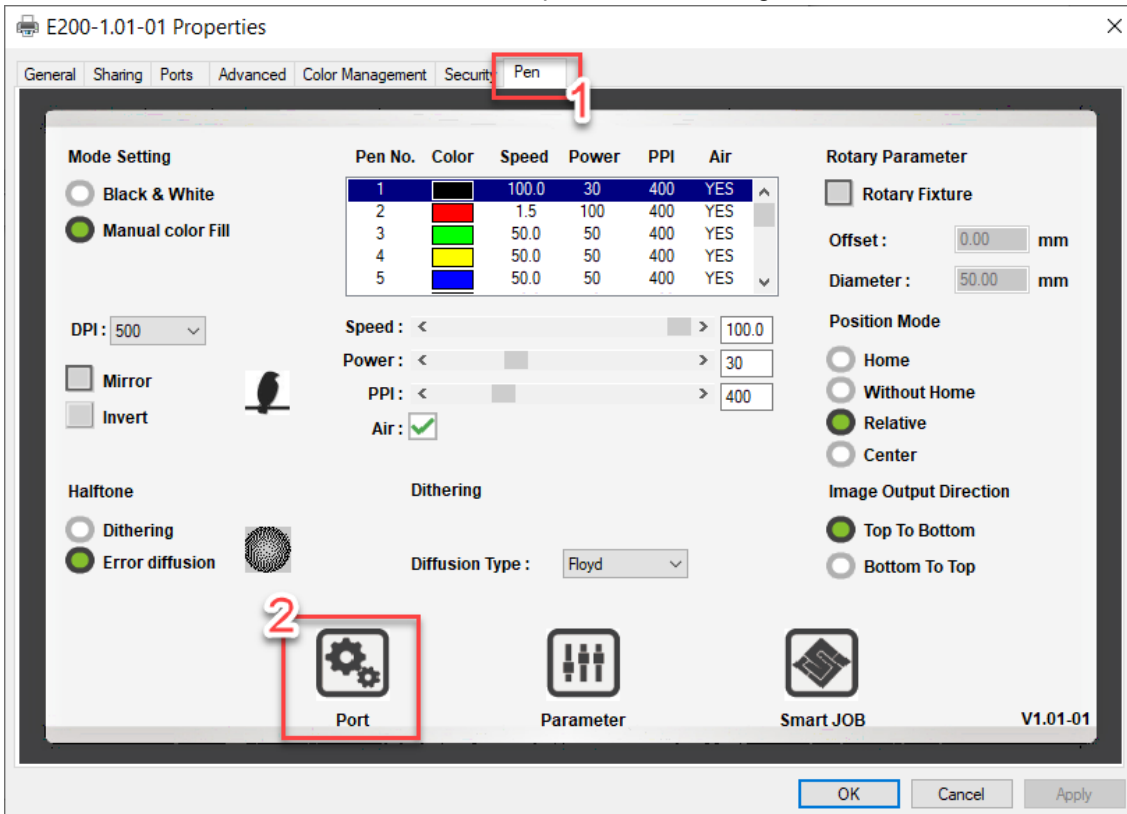

5) Select "LAN/Wifi" button and click "OK" button to open the setting window

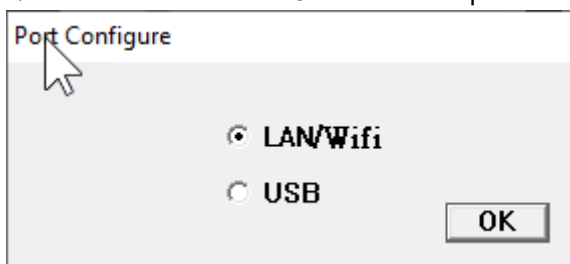

- 6) Double click your machine from the Device List and the setting is complete. Please check your serial number of the machine to make sure the connection is correct if you have many machines.

IPAddr	DevName	DevID	MacAddr
192.168.215.157	U90588(LAN)	T1MB285858(LAN)	08-1F-71-29-27-7A

- 7) WiFi/LAN Connection setting is completed.

USB

- 1) Go to "Control panel" → "Devices and Printers"

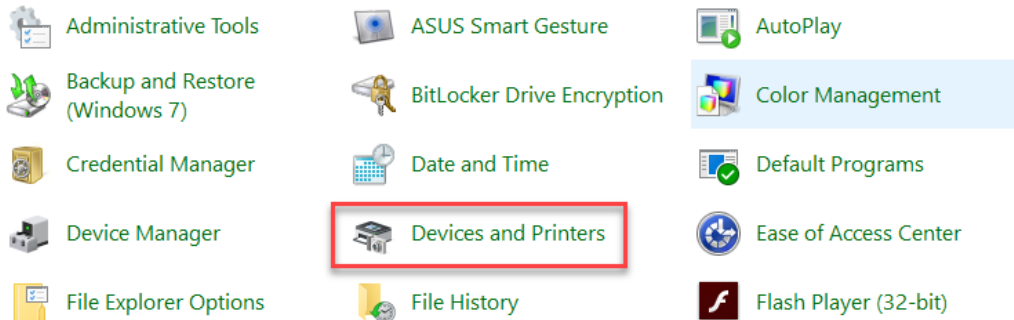

- 2) Double click "E200S" printer driver to open the printer driver window

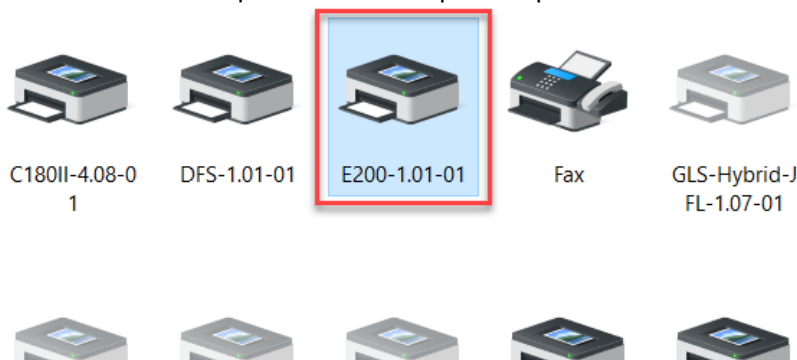

- 3) Click "Printer" → "Properties" on the menu bar to open the properties window.

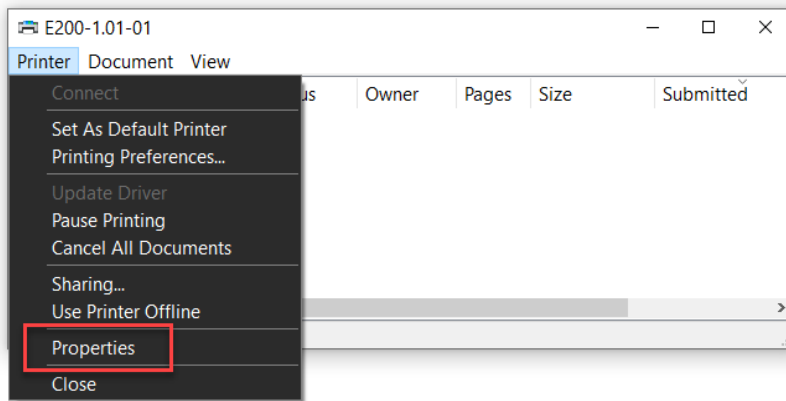

4) Click the “Pen” tab and click “Port” button to open the Port Configure window

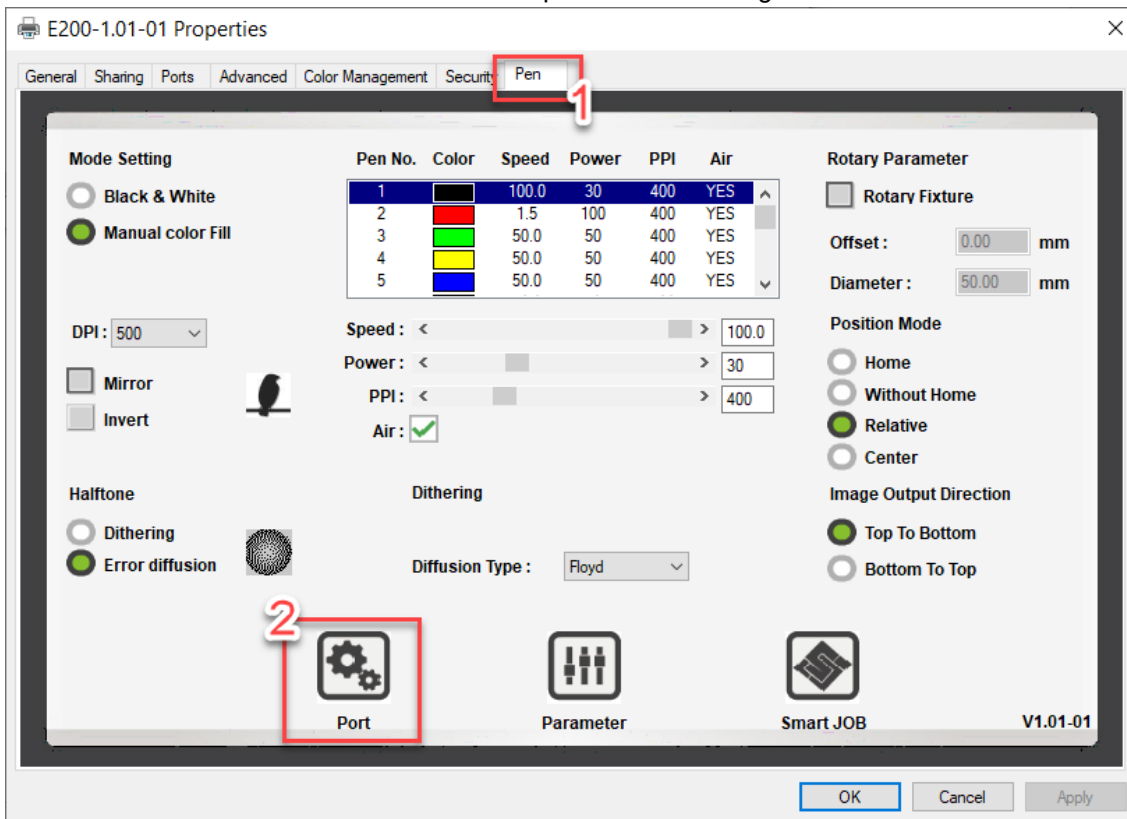

5) Select “USB” button and click “OK” button to open the setting window



6) “USB” Connection setting is completed.

6.3 Connection Troubleshooting

For above Wi-Fi connection, E200S Connection Wizard will select the available IP automatically, if you want to appoint specific IP, please follow below steps.

- 1) Connect the USB cable between the machine and computer.

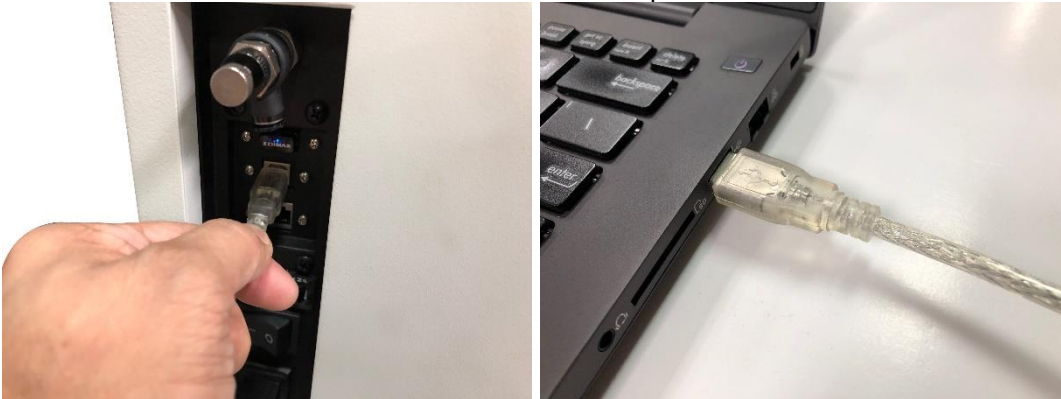

- 2) Open E200S Connection Wizard program. You can find the program in the installation CD.

Field	Ethernet	WiFi
Device	USB002 PID:8136 E200 U90588	USB002 PID:8136 E200 U90588
Country	*Taiwan	*Taiwan
SSID		
DHCP	<input type="checkbox"/>	<input checked="" type="checkbox"/>
IP Addr	0 . 0 . 0 . 0	192 . 168 . 0 . 102
Mask	0 . 0 . 0 . 0	255 . 255 . 255 . 0
Gateway	. . .	192 . 168 . 0 . 255

Note: Please make sure that the program can find the “Device” and “Country” before you set the static IP for E200S.

- 3) Uncheck the checkbox of the “DHCP” and enter the IP address, Mask, and Gateway in the boxes according to your connection way.

Please ask your MIS person to provide the IP address, Mask, and Gateway for you.

- Static IP for Ethernet

Field	Ethernet	WiFi
Device	USB002 PID:8136 E200 U90588	USB002 PID:8136 E200 U90588
Country	*Taiwan	*Taiwan
SSID		
DHCP	<input type="checkbox"/>	<input type="checkbox"/>
IP Addr	00 . 49 . 03 . 45	. . .
Mask	07 . 11 . 06 . 51	. . .
Gateway	00 . 68 . 06 . 37	. . .

● Static IP for Wi-Fi

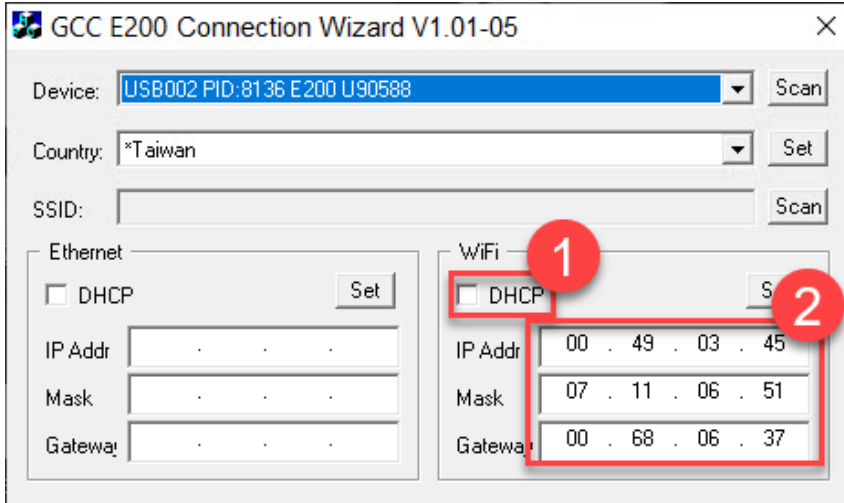

4) After entering those parameters, click the "Set" button to save the setting.

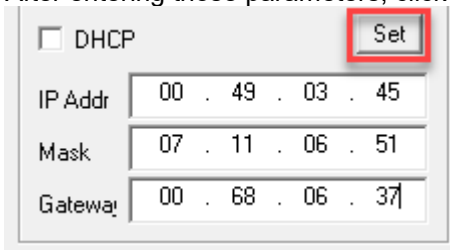

5) The setting is completed.

Chapter **7**

Operating the GCC LaserPro E200S

How to use Focus Tool

SmartJOB Software Operation

The LaserPro E200S Print Driver

E200S Touch Panel Operation

7.1 How to use focus tool

Use the focus tool to do manual focus.

a. Place the focus tool this way to do manual focus with nozzle.

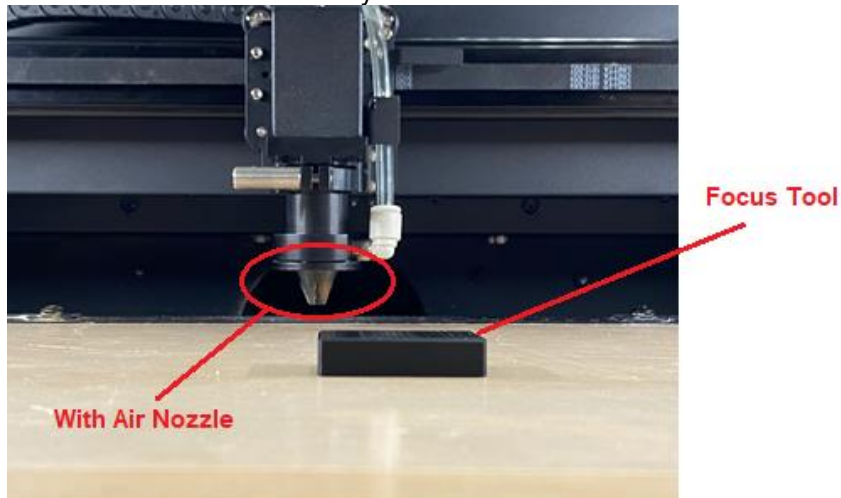

b. Place the focus tool this way to do manual focus without nozzle.

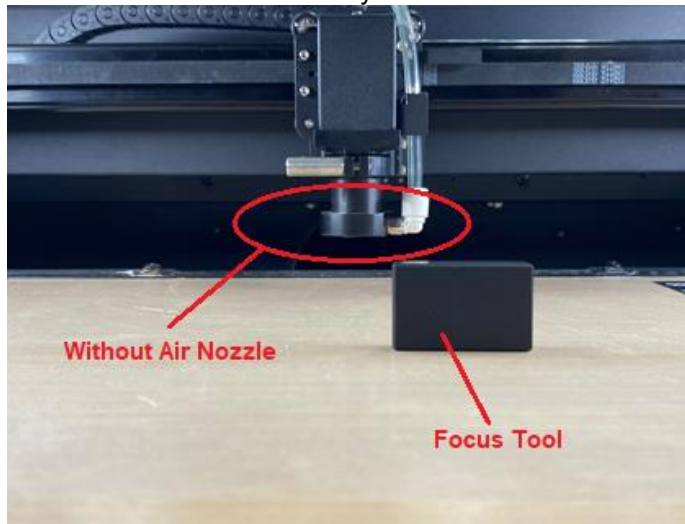

1. Use a knob on the carriage to adjust the focus distance.

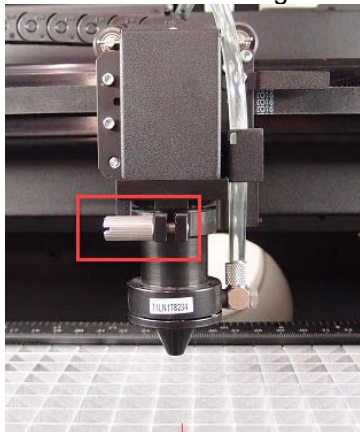

2. Place the focus tool between the material and the carriage, the following picture shows the focus distance with the nozzle installed.



3. Place the focus tool between the material and the carriage, the following picture shows the focus distance with the nozzle installed.

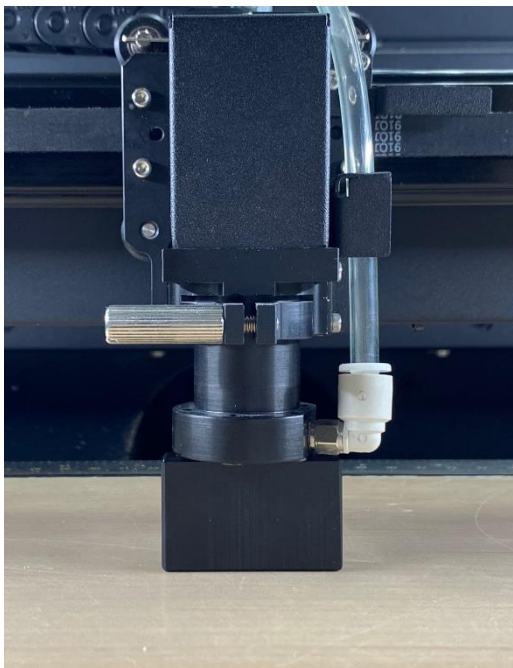

4. Send the file to E200S machine.
5. Press "Start" on the touch panel to begin laser output.



7.2 SmartJOB Software Operation

7.2.1 User interface introduction

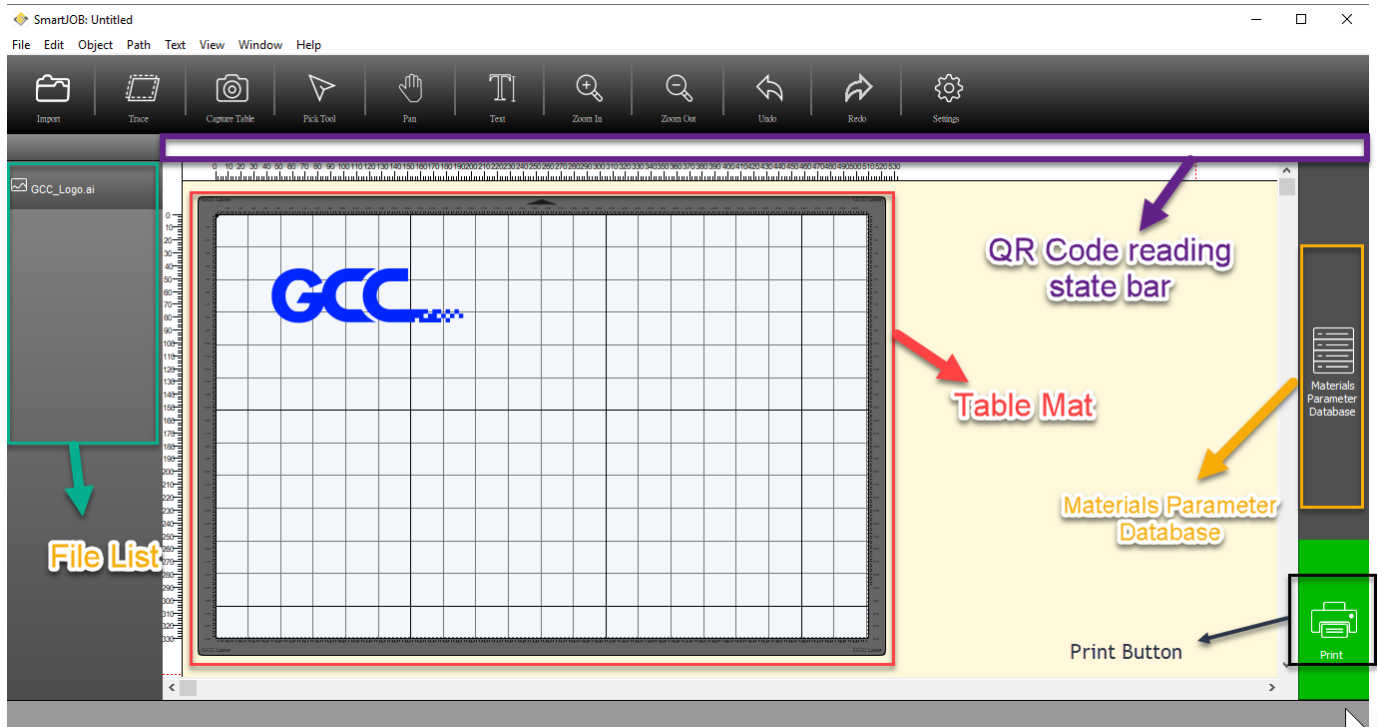

Table Mat: Display the real-time table and object view

QR Code reading state bar: Show the barcode reading state.

File List: Show the file history (Max. 4pcs)

Materials Parameter Database: Allow users to choose the processing parameter according to different materials.

Print Button: Send the file to the machine

7.2.2 Functional Introduction



Import: Allow user to open/import files (available for JPG, BMP, PNG, EPS, PDF, SVG, AI formats)

Trace: Allow user to trace image and do contour.

Capture Table: Take a table photo (including the object) and read the barcode one the material

Pick Tool: To select, position or transform objects.

Pan Tool: Drag hidden areas of a drawing into view without changing the zoom level.

Text: Allow to add/edit texts to your job.

Zoom out: Decrease the magnification level to view a large portion of the document.

Zoom in: Increase the magnification level to view more detail.

Undo: Cancel the previous action.

Redo: Reapply the last undone action.

Settings: Allow to set Metric/Imperial & connection setting up.

7.2.3 Trace Image Files

SmartJOB allows you to import image files (ai., bmp., jpg., gif., png. etc... formats) and will trace the image for cutting. Please note, results may vary depending on the source image file. To trace an image, choose "Trace Image" from the File menu, or click the Trace toolbar button.



Step 1 Select Trace Image button on the toolbar to open the setting window.

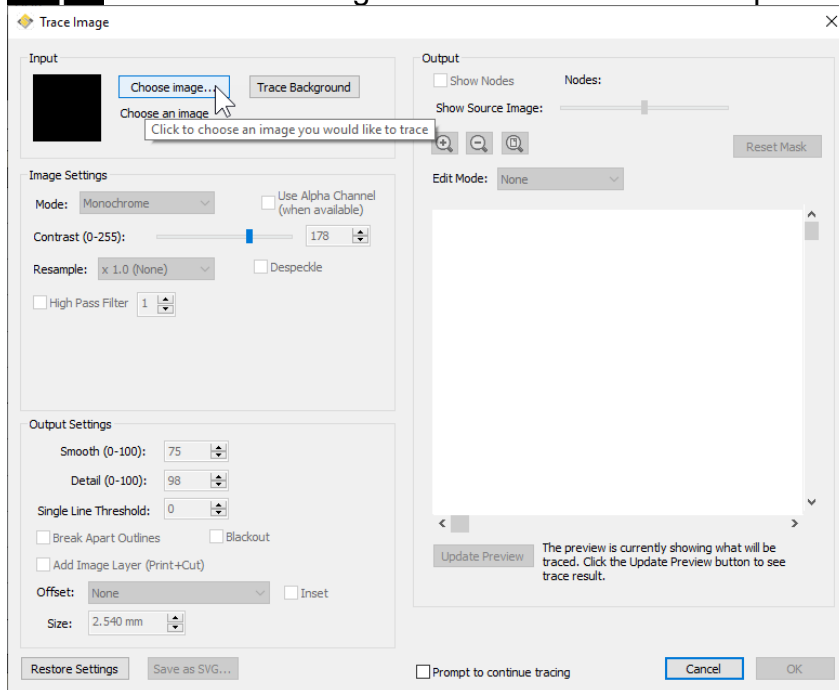

Step 2 Click on "Choose an image" to input the image, adjust Image Settings and Output Settings, and click OK. Then the outline of the image will be outputted automatically.

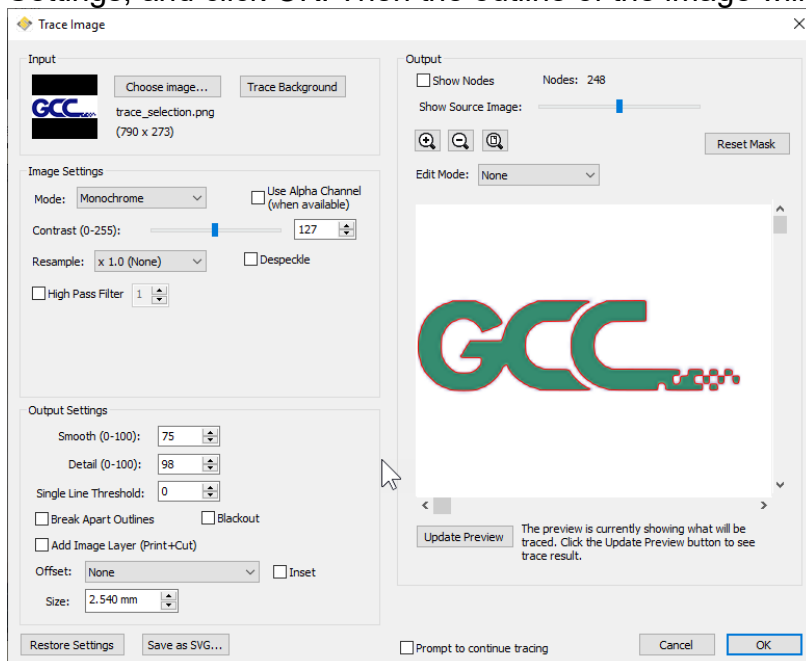

Input Settings

Choose an Image: click “Choose an image...” button. The program can accept most files (.bmp, .jpg, .gif, .png).

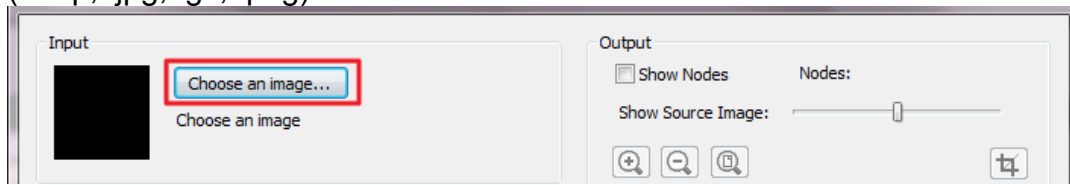
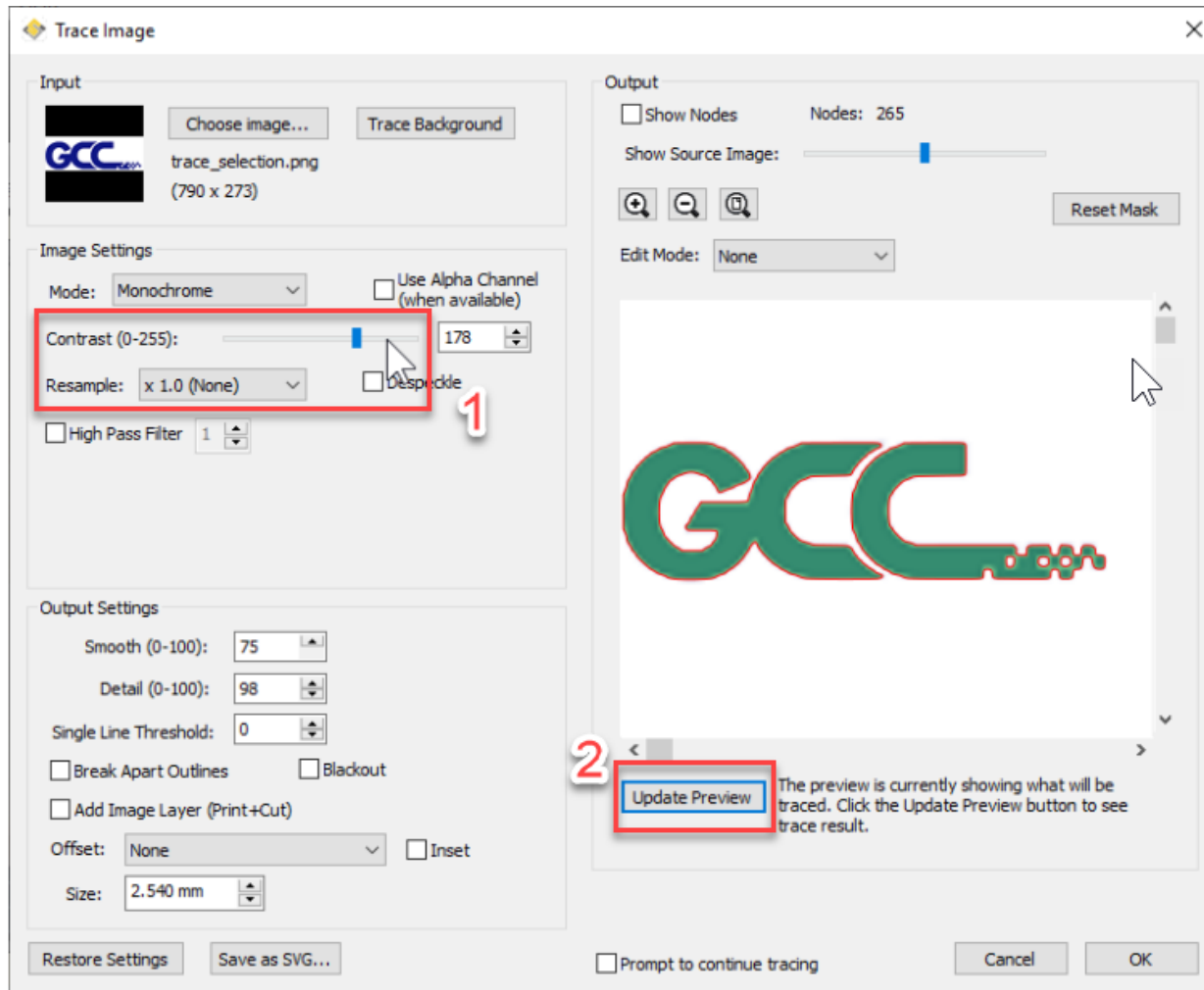

Image Settings

Mode: choose which tracing mode you would like to do.

Monochrome - will trace as if the image is a black and white image.

Contrast: this value will determine the cutoff to whether parts of the image should be traced. When you adjust the contrast value, the preview will change to a black and white image showing what parts of the image will be traced. To see trace results, click the “Update Preview” button.



Color layers - will segment the image into the specified number of colors.

Max Colors - the maximum number of colors to segment the image in to. You can turn off colors by clicking on the color boxes. To see trace results, click the “Update Preview” button.

Single Color - choose a specific color from the image to trace. To choose a color, click the color button, and then click on the preview image to choose a color.

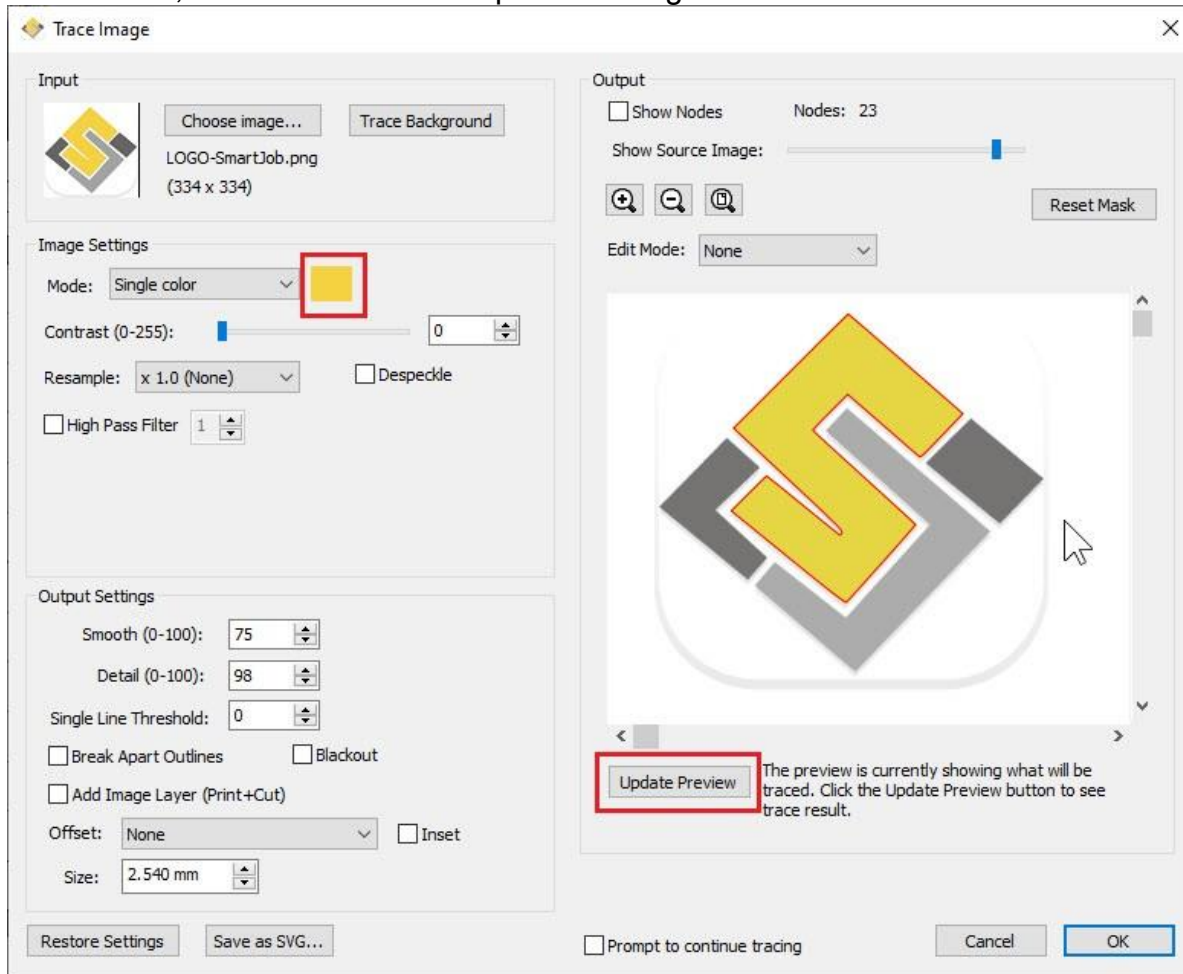

Output Settings

Smooth: higher values will result in a smoother trace.

Detail: lower values will remove smaller shapes

Single Line Threshold: this can be used if you are tracing images that have outlines shapes that are not filled solid to prevent having double lines.

Break Apart Outlines: if checked, the trace result will be saved as separate layers for each outline created.

Blackout: removes internal outlines.

Add Image Layer (Print+Cut): adds the source image as a layer under the traced outline, and sets the traced outline layer to "Print+Cut Cut" so that it will only be cut and not printed.

Note

- ✓ The **contrast** and **pixels** of import images will affect the trace image result. High contrast graphics are recommended.

7.2.4 Engraving & Cut by SmartJOB (workflow)

Step 1 Place the GCC Material to E200S machine.

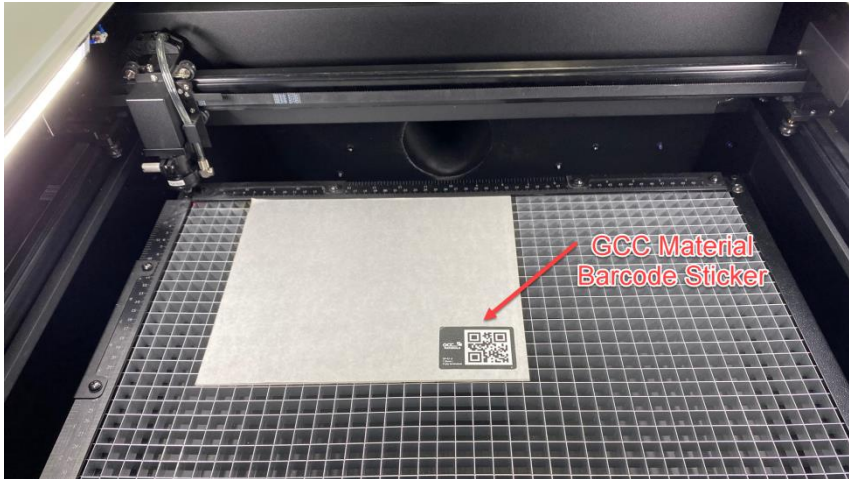

NOTE: Every material piece which comes with E200S has a specific barcode on the surface of the material. When removing protection foil, please do NOT remove the QR code sticker.



Step 2 Open the SmartJOB software and import the file which you'd like to process.

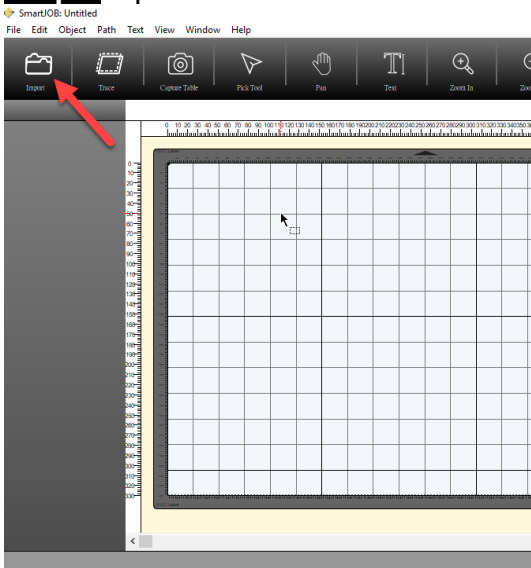

Step 3 After loading the file, please click “Capture Table” to take a photo of working table and E200S camera will scan the barcode which stick on the GCC materials.

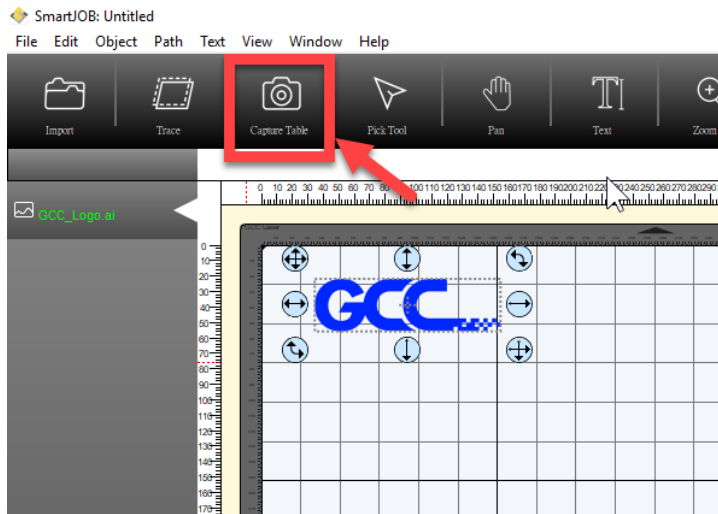

Step 4 Once “Capture Table”, camera will also scan the barcode sticker which is on the material too.

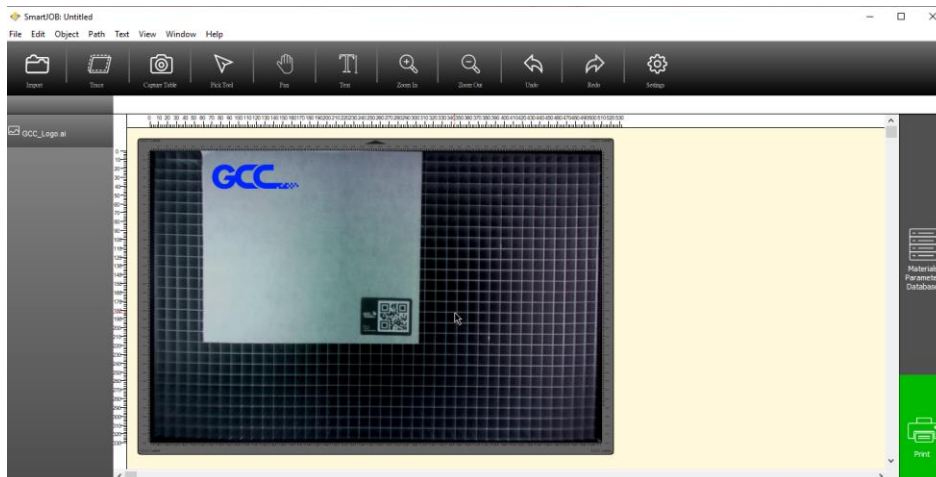

Step 5 Go to file list, and click the right mouse button, SmartJOB will set up the parameter according to different materials automatically.

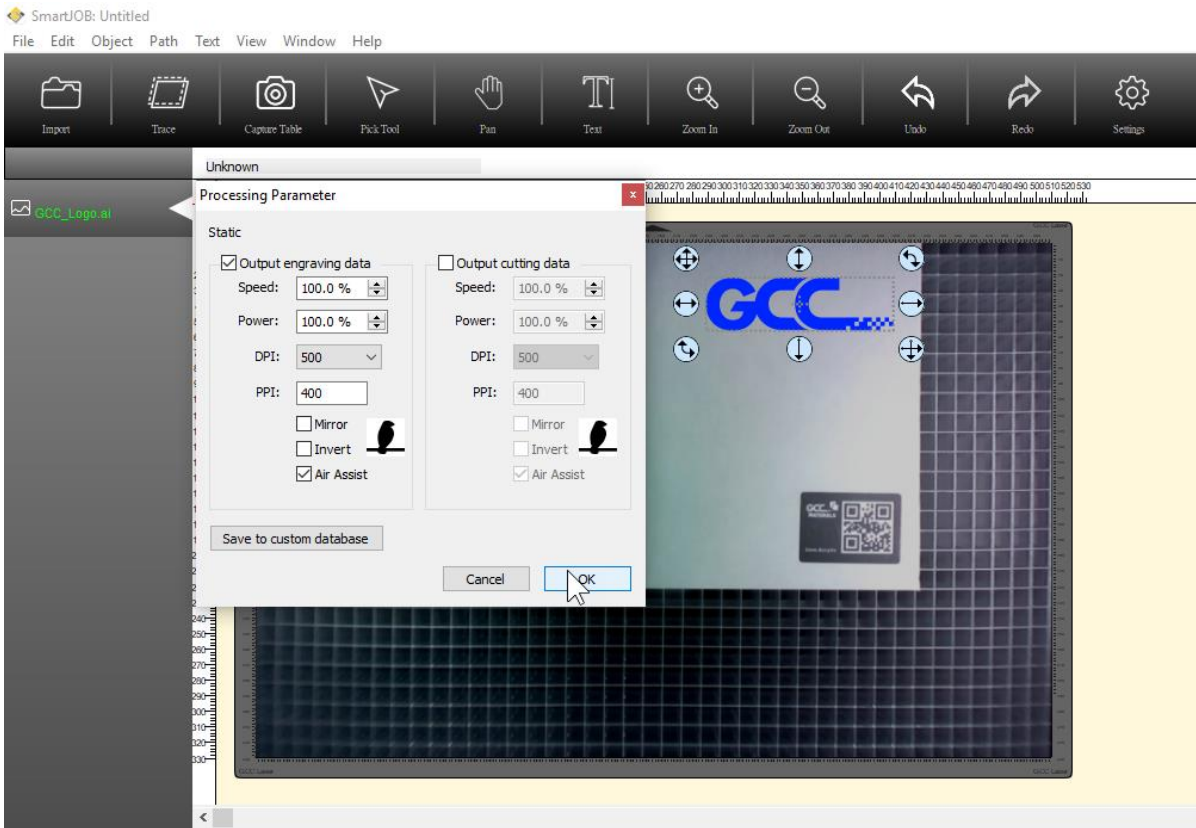

Step 6 Parameter setting is ok, press print to process the engraving job.

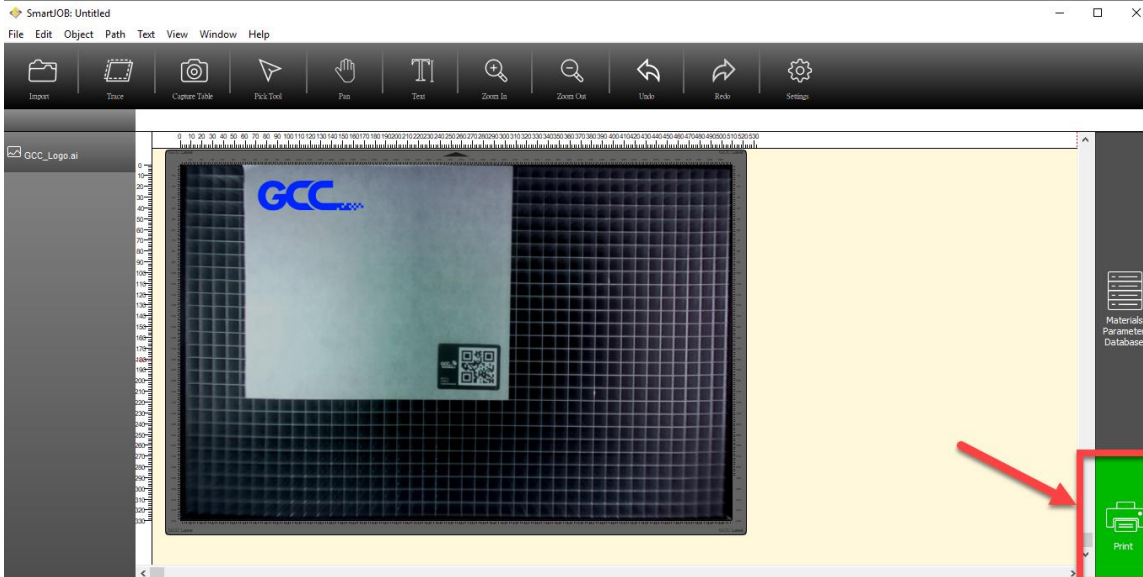

Step 7 If you have adjusted the parameter, you can save the parameter into the material database and name it yourself.

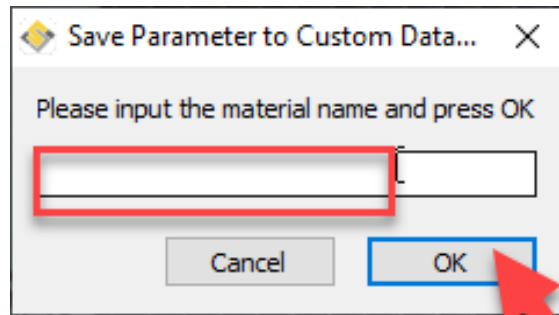
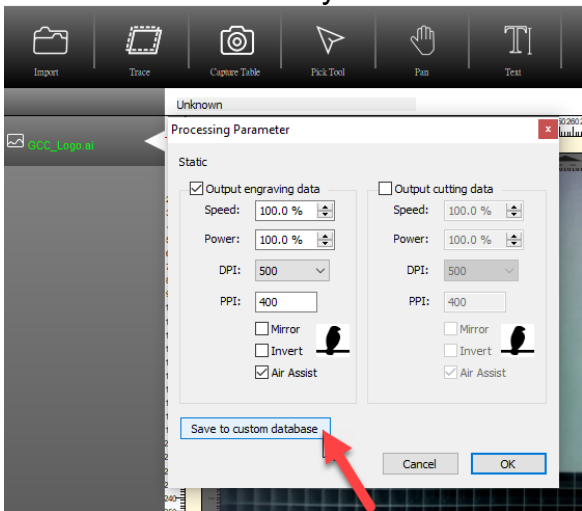

Step 8 The parameter will be saved to “Customer Parameter Database” as below

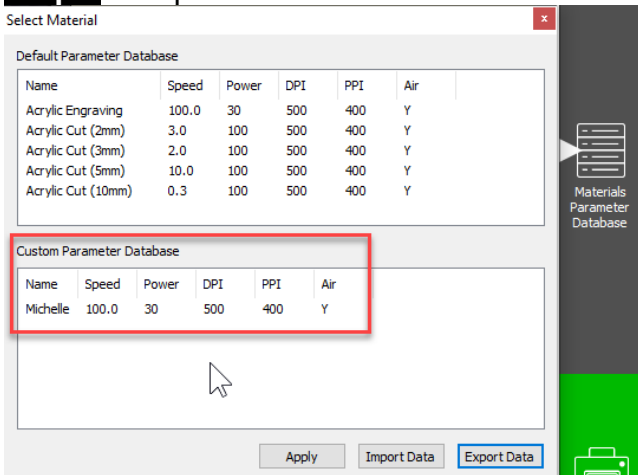

Step 9 Here you can also do the export parameter data or import data.

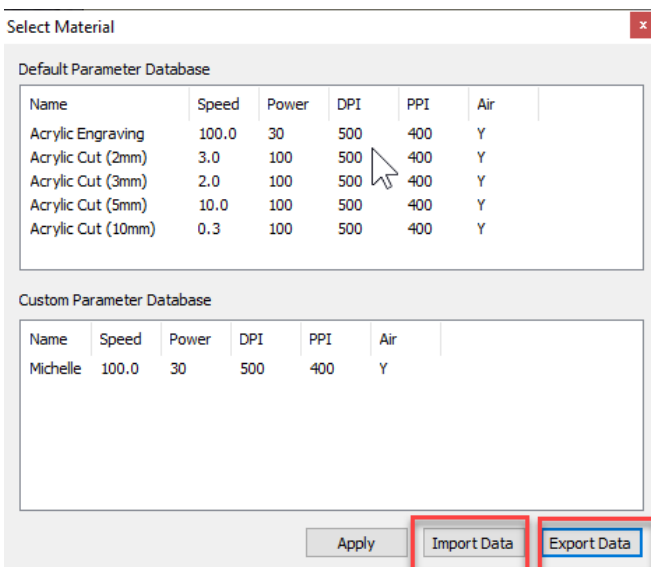

7.3 The LaserPro E200S Print Driver

With the LaserPro E200S print driver successfully installed, you will need to adjust the printer and page size default settings before you can begin editing and completing jobs. By doing so, you will be setting the work area in your graphics software to match the LaserPro E200S's worktable area.

NOTE

Please make sure the LaserPro E200S is set to the default printer before proceeding to the page and layout setup.

Ensure that the LaserPro E200S has been selected as the DEFAULT PRINTER. You can do so by going into your Windows Control Panel → Printers and Faxes.

If LaserPro E200S is not selected as DEFAULT PRINTER, you may set it up through the graphics software as well. The following is taking Corel Draw as example of how to set up LaserPro E200S as the Printer.

- 1) From the primary menu, click FILE → PRINT SETUP.
- 2) From the navigation bar Name, click E200S → OK

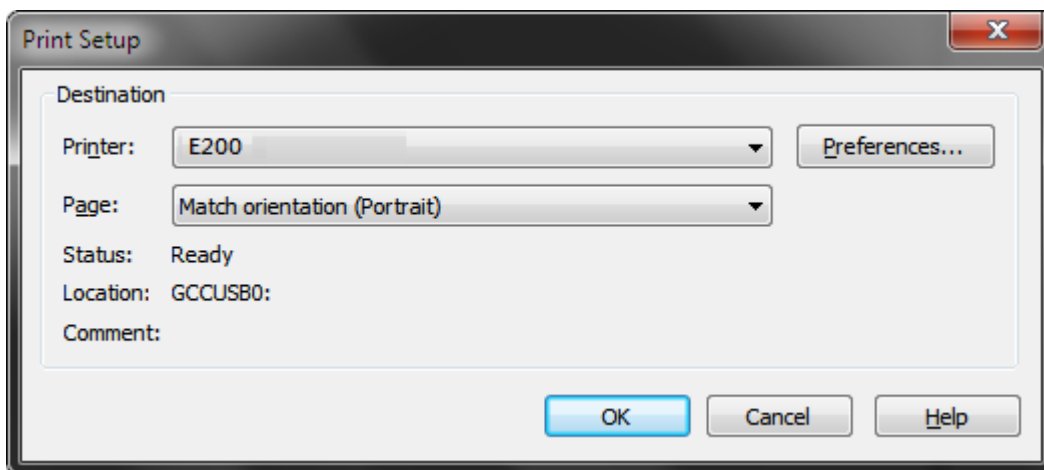

7.3.1 Page Setup and Orientation

The first thing you must do before working with the LaserPro E200S Print Driver will be to make sure the page and layout settings are properly configured within your graphics software. You will need to access and edit the Page Setup or Layout page of your graphics software to set your graphics software's page layout to match the LaserPro E200S's work table's dimensions and orientation.

From your graphic software's Page Setup page:

- Set the page orientation in the graphics software to Landscape mode.
- Set page size horizontal length to 510 mm (20 inches) and vertical height to 330 mm (12.9 inches)

CoreIDRAW Example (Page Setup and Orientation)

The following is an example of how to set the Page Setup and Orientation in the graphics software. CoreIDRAW is the designated graphics software used for this example. For other graphics software, you will need to access the corresponding Page Setup page.

- 3) From the primary menu, click LAYOUT → PAGE SETUP.
- 4) From the navigation bar on the left, click DOCUMENT → PAGE → SIZE.
- 5) Ensure that NORMAL PAPER and LANDSCAPE are selected.
- 6) Ensure the Paper Width and Height dimensions match the LaserPro E200S's work table dimensions of 510mm (20 inches) and 330 mm (12.9 inches).
- 7) Click OK to complete the paper size adjustment.



Tip

Instead of manually selecting the Landscape and setting the Paper Width and Height, you can simply click the Set From Printer function and CoreIDRAW will automatically set the proper orientation and dimensions based on LaserPro E200S's work table. (You MUST have the LaserPro E200S set as the default printer prior to doing this.)

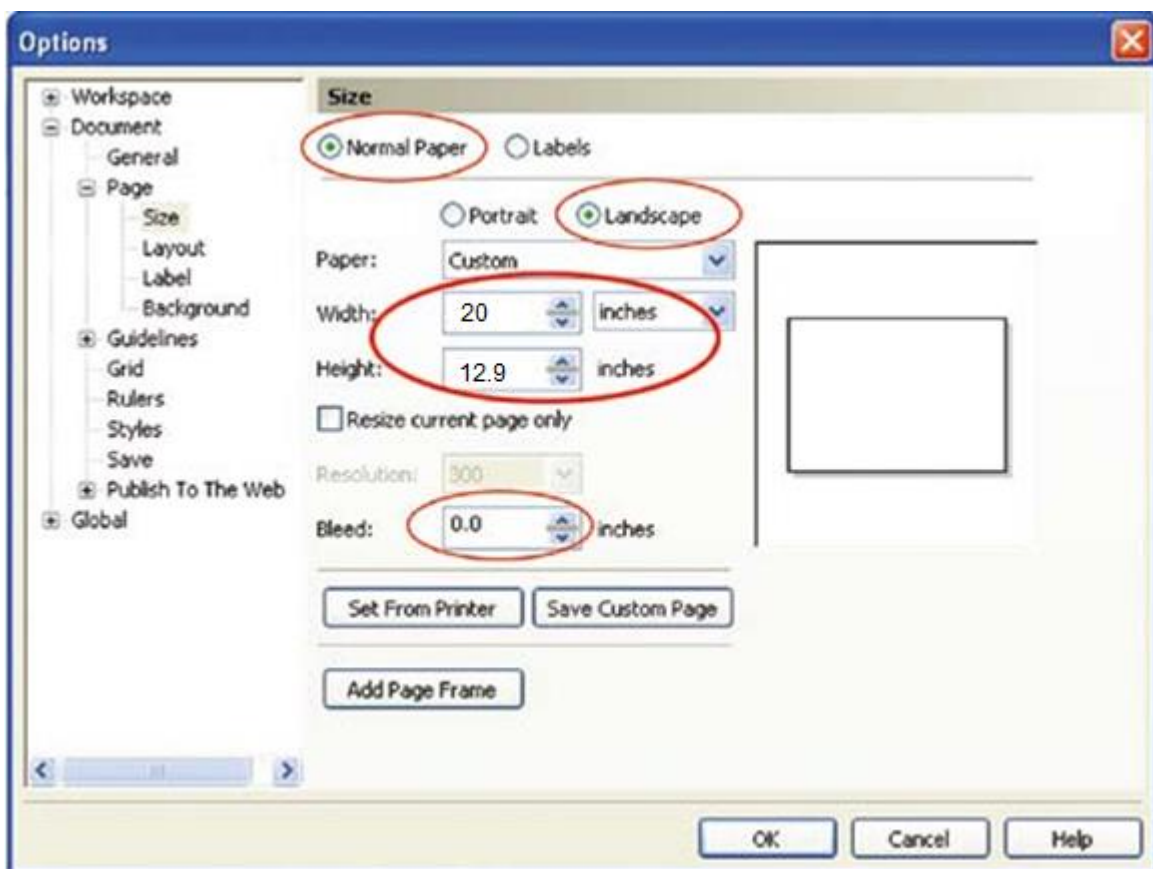

7.3.2 Color Management

LaserPro driver uses pen color settings to control laser engraver engraving and cutting parameters. In addition to having your Page Setup and Orientation properly set in your graphics software, you will also need to make sure Color Management is DISABLED prior to working with the LaserPro E200S Print Driver

From your graphic software's Color Management page:
Disable Color Management or set Color Management to Off.

CorelDRAW Example (Color Management)

The following is an example of how to properly disable Color Management in the graphics software. CorelDRAW is the designated graphics software used for this example. For other graphics software, you will need to access the corresponding Color Management page.

- 1) From the primary menu, click TOOLS → COLOR MANAGEMENT and CorelDRAW's Color Management will appear.
- 2) Under the Style pull down menu, select COLOR MANAGEMENT OFF.
- 3) Click OK to complete the color management adjustments.



7.3.3 Using the LaserPro E200S Print Driver

Now after you have properly set the Page and Layout and Color Management of your graphics software, you are ready to configure the details of your actual job through the LaserPro E200S Print Driver. The LaserPro E200S print driver allows you to adjust your engraving / cutting options. After you have setup your image, design, or text to be engraved in your software application, you can access the LaserPro E200S print driver by going to FILE → PRINT → PROPERTIES.

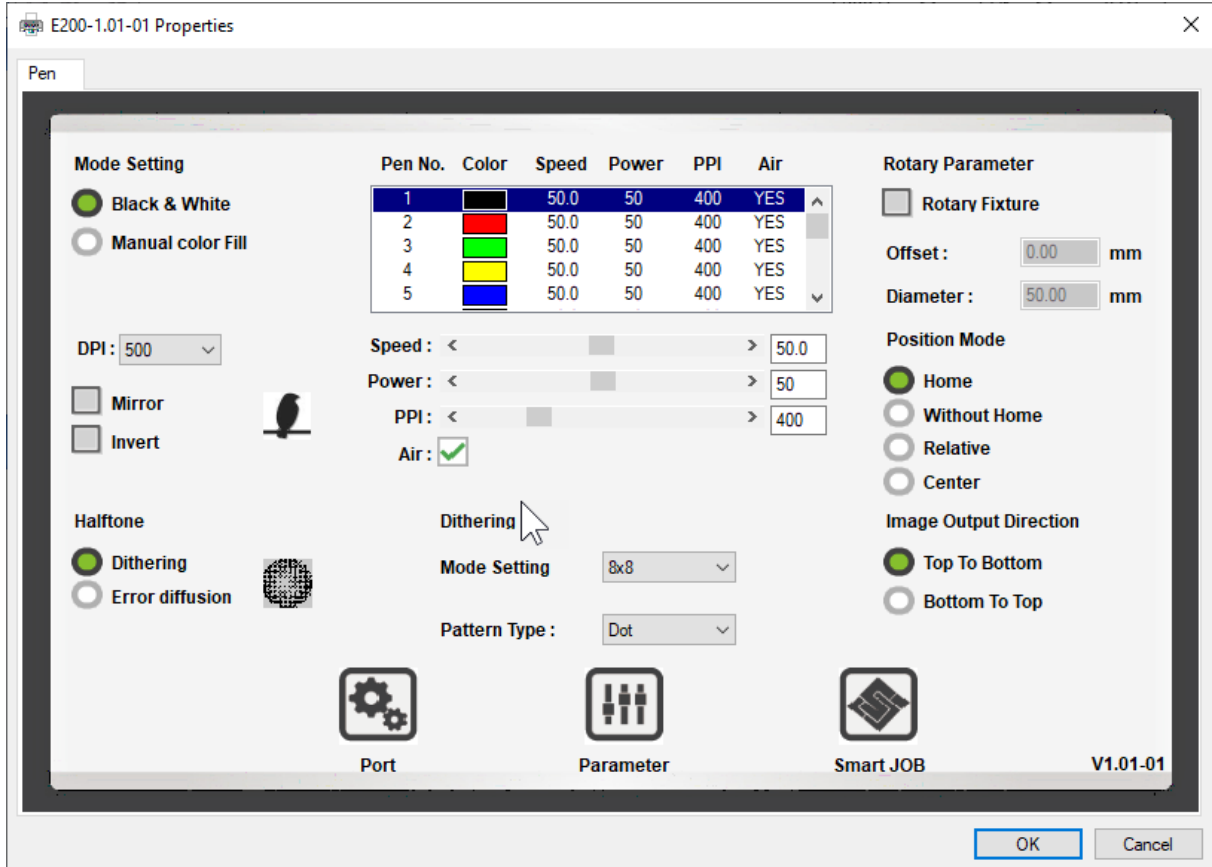

NOTE

For this screenshot example, CoreIDRAW was used as the software application.

The LaserPro E200S Print Driver for advanced users which enable to choose various engraving / cutting options and settings

7.3.4 Using the LaserPro E200S Print Driver >> Pen Page

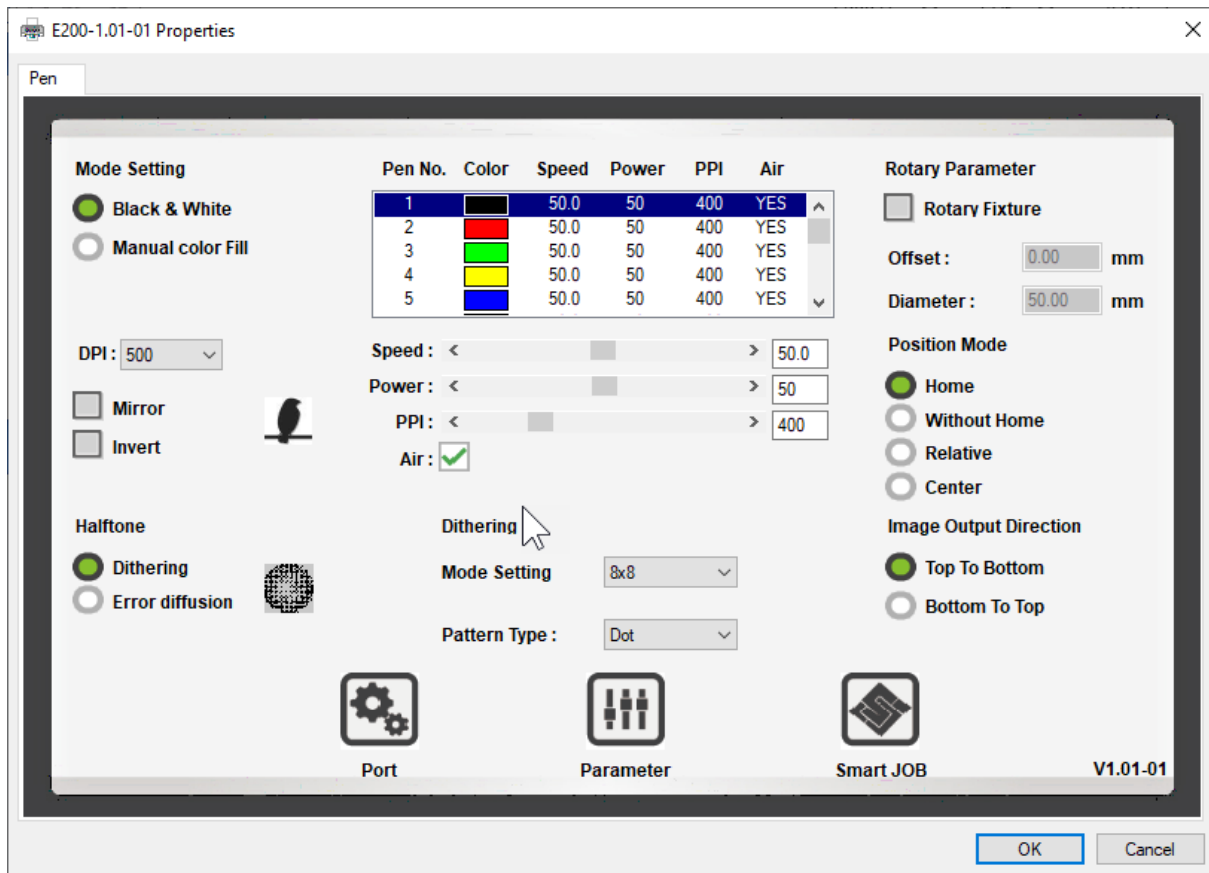

Mode Setting [DEFAULT SETTING: Black & White]

You can select four primary mode settings, depending on your application or results you would like to achieve.

Black & White: Select this mode when using clipart images or drawings with several colors, shades of gray, or many outlines. This mode outputs in a method similar to that of a black and white laser printer. The entire selected image will be engraved using a single set of power & speed settings (the black pen from the PEN menu. Please refer to the next section of the manual for details regarding the PEN functions). The LaserPro E200S print driver will interpret colored and shaded areas as different shades of gray by producing a halftone effect while engraving. Instead of engraving only solid lines, gray/halftone areas will be a collection of dots with varying density.

The resolution and depth of these halftone areas can be adjusted with the DPI setting found on the Options page. Please note that selecting the Black & White mode will add a new Raster page to the menu. The Black & White mode dithering settings can be changed from the Raster page. (Please refer to the Raster section below for details). Experiment with different dithering settings to attain the desired results.

Tip





The Black & White mode interprets the processed image by the varying colors and shades. For the best results, we suggest you convert the image to a grayscale image with your graphics software prior to engraving in the Black & White mode.

NOTE

Selecting the Black & White mode will enable the Raster page on the LaserPro E200S Print Driver, allowing you to adjust advanced stamp-related settings.

Manual Color Fill:

Specify laser type to different color pens. The GCC LaserPro print driver allows a maximum of 5 pen parameters to be set. It will help user to set different parameters easily in one file.

Pen No.	Color	Speed	Power	PPI	Air
1		50.0	50	400	YES
2		50.0	50	400	YES
3		50.0	50	400	YES
4		50.0	50	400	YES
5		50.0	50	400	YES

Speed: < >

Power: < >

PPI: < >

Air:

DPI [DEFAULT SETTING: 500]

DPI (dots-per-inch) represents the number of times the laser will fire over a one-inch path. This setting determines the image resolution and quality when performing raster engraving functions. Higher DPI settings result in cleaner and deeper engravings, but require a more time to complete. Lower DPI settings result in coarser and shallower engravings, but require less time to complete. The LaserPro E200S offers 8 DPI options: 250, 380, 500, 760 and 1000 experiment with different settings to get your desired effect.

Below is a chart for your convenience detailing the Set DPI (your input setting) vs. Actual DPI (your output results).

Set DPI	250	380	500	760	1000
Actual DPI	254	381	508	762	1016

NOTE

Outputting a full-table (25.1" x 18.1") job using 300 or 600 DPI will result in a truncation error; this is due to the large differences in set DPI vs. actual DPI output for those two particular DPI settings. Therefore, when processing a 25.1" x 18.1" job using 300 DPI, we recommend you move to the next higher DPI setting of 380. Similarly, for a 25.1" x 18.1" job using 600 DPI, we recommend you use 760 DPI.

Please note that when using Illustrator for output, the vector function supports a DPI range of 380 - 1500.

Mirror [DEFAULT SETTING: Unselected]

Checking this box will automatically engrave your image with a mirrored effect. This setting will flip the image along the Y-axis from left to right and vice-versa.



Tip

When engraving a stamp, via the stamp mode, the stamp image needs to be engraved in reverse (mirrored) for the final stamp to be correctly laid out.





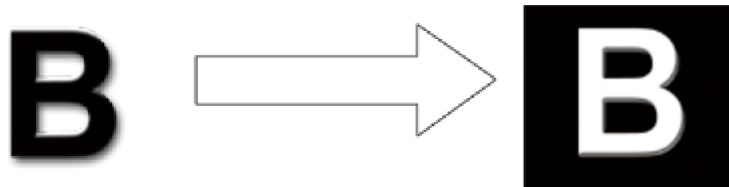

Invert [DEFAULT SETTING: Unselected]

Checking this box automatically inverts / reverses the color of your image (the white areas become black and vice versa). The Invert option is not available in disabled with Manual Color File mode selected.



PEN [DEFAULT SETTING: Speed 50, Power 50, PPI 400]

The LaserPro E200S incorporates the use of 5 different colors to represent 5 different laser power and speed settings when cutting and engraving. These colors are referred to as "Pen". Think of each pen as a designated laser setting, rather than as a color. As an example, a black and white image will use only one power and speed laser setting (Black). An image that is made up of black, red and blue colors will be processed using the laser settings designated for each particular color. In order to utilize up to 5 different pens (laser parameter settings), make sure your graphics software can recognize and utilizes the 5 pen colors designated by the LaserPro E200S print driver.

Pen No.	Color	Speed	Power	PPI	Air
1		50.0	50	400	YES
2		50.0	50	400	YES
3		50.0	50	400	YES
4		50.0	50	400	YES
5		50.0	50	400	YES

Speed: <  > 50.0

Power: <  > 50

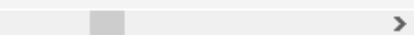
PPI: <  > 400

Air:

NOTE
 The LaserPro E200S print driver cannot store more than 5 pen colors or different laser parameter settings per file.

Speed (Pen Page) [DEFAULT SETTING: 40]

The speed slider controls the laser’s speed during operation (engraving speed) with settings ranging from 0.1 – 100%. Only when moving in straight line with enough distance, the carriage can achieve 100% speed. On the other hand, the machine will automatically slow down when processing curves so the speed % indicator only presents maximum speed % that laser can achieve but not equal to actual laser carriage moving speed. It is exactly like driving a car on a straight road, you can driver faster and on a curve road you have to slow down.

Laser pulse frequency is controlled by the speed setting for vectors and it is opposite to pulse width, meaning higher speed setting for vectors, lower pulse width, and thus less cutting capability. Not only speed% setting affects actual processing time but also the job size, complexity of the graphic and the position of the graphic in the working area..

Power (Pen Page) [DEFAULT SETTING: 50]

The power slider controls the laser’s power during operation (engraving/cutting power) with a range setting from 0 – 100%. The percentage setting represents the power for each laser pulse fired. The lower the power setting, the shallower it engraves or cuts, and vice-versa.



Tip

.....
 Cutting / engraving depth are determined by a combination of power and speed. Slower speed at higher power will produce deeper cuts and engravings, whereas higher speeds at lower power will produce more shallow cuts and engravings.

PPI (Pen Page) [DEFAULT SETTING: 400]

PPI (pulses-per-inch) represents the pulsing frequency of the laser pulse (fire) numbers within an inch exclusive for vector cutting. Higher PPI settings may cause more melting, burning or charring on the

edges when cutting. Lower PPI settings may reduce this effect, but may result in a serrated looking edge. If you drag the PPI slider to the maximum, the value will change to X. This completely disables the PPI control and turns on the laser continuously without pulsing. This disables the power ramp functionality, which automatically controls the PPI depending on the speed of the laser carriage (such as vector cutting around the corner of a square). With PPI to X, the cutting corner with slower speed will generate over burn or melting.



Tip

1. When cutting thicker materials, suggest setting PPI to X and slow speed setting to melt/cut through the material
2. When cutting thin material or do kiss-cutting, it is recommended to set the PPI value to 400 and slower speed setting to keep curve and line with consistent cutting result, no over burn in corner.

Air [DEFAULT SETTING: Unselected]

This checkbox controls the SmartAIR air-assist function (if you have the optional air compressor installed). By selecting a pen color and checking this box will enable the SmartAIR air-assist function for that particular pen color. As an example, if you are performing a combination of both surface raster engraving job and deep vector cutting on a material such as acrylic, you may want to enable the SmartAIR air-assist for the vector cutting sections to get the cleanest cuts. To do this, you would simply need to select the pen color that you have assigned to the sections to be cut and select the Air checkbox for those particular pen colors.

Position Modes [DEFAULT SETTING: Home]

These selections allow you to control the positioning of the laser head after each job completion and before the next subsequent job.

- **Home:** Resets the positioning of the laser head to the "home position" (upper-right) before and after each job.
- **Without Home:** The laser head will start the next job based on its position from its graphic application software setting, from the last position of the previous job. Upon completion of the current job, the laser head will remain at the last position of the previous job.
- **Relative:** This mode sets the current laser head position to correspond to the origin (top left) position of the graphic software. Therefore, the laser head will process the job from its current position relative to its setting in the graphics software.
- **Center:** Sets the current position of the laser head as the center point for your subsequent job. As an example, if the subsequent job is to vector cut a circle and you have the Position Mode set to Center, then the E200S will vector cut a circle around the initial position of the laser head.



Tip

It is highly recommended you enable the red dot laser pointer when setting / adjusting the Position Modes, as this makes accurate positioning of your laser carriage for your particular jobs much easier.

Image Output Direction [DEFAULT SETTING: Top To Bottom]

These selections allow you to control the direction in which the system processes an engraved image.



- **Top To Bottom:** Selecting this will force the system to process the current task by moving the laser carriage from the top to the bottom of the image (rear end to front end of the work table).
- **Bottom To Top:** Selecting this will force the system to process the current task by moving the laser carriage from the bottom to the top of the image (front end to rear end of the work table)
(Normally, the LaserPro E200S engraves from left to right, top to bottom. Selecting Bottom Up will force the machine to start from the bottom and work its way to the rear of the working table.)



Tip

.....
In situations where the material you will be working with may produce a lot of dust byproducts and you are utilizing the optional Fume Extraction system, it is recommended you select the Bottom To Top image output direction option. This will minimize the amount of dust byproducts lodged in the engraved sections as the Fume Extraction system is vented from the rear of the machine, the same direction as the image is processed.

Halftone [DEFAULT SETTING: Dithering]

This option controls the way a raster-engraved image is processed. The “digital image to engraved output” process can be processed via two methods: Dithering or Error Diffusion. Each offer additional output options yielding different output effects, style, and quality.

- **Dithering:** Interprets and outputs the raster engraving via the dithering method. This mode will allow you to select the Pattern Type and Dithering Matrix, and Enhanced Dithering.

- **Pattern Type: Dot, Bayer, Corner, 45 Degree** [DEFAULT SETTING: Dot]

Each pattern type uses a different shape and arrangement of dots to compose the shading effect of a raster image.

The following diagram is an example of the raster effects when using the different pattern types.

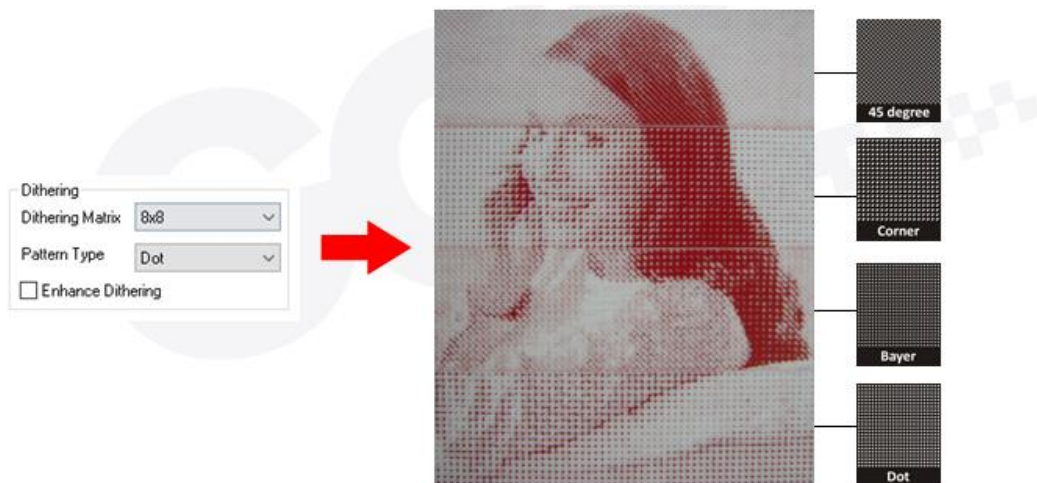

- **Dithering Matrix: Variable depending on the Pattern Type selected.**

[DEFAULT SETTING: 8 x 8]

This controls the resolution (dot size) and the number of dots the image is broken down into for the dithering process. As an example, selecting 2 x 2 will shade with a 5-grade halftone, whereas an 8 x 8 Dithering Matrix will dither with a 65-grade halftone. The following diagram is an example of the raster effects when using the different dithering matrices.

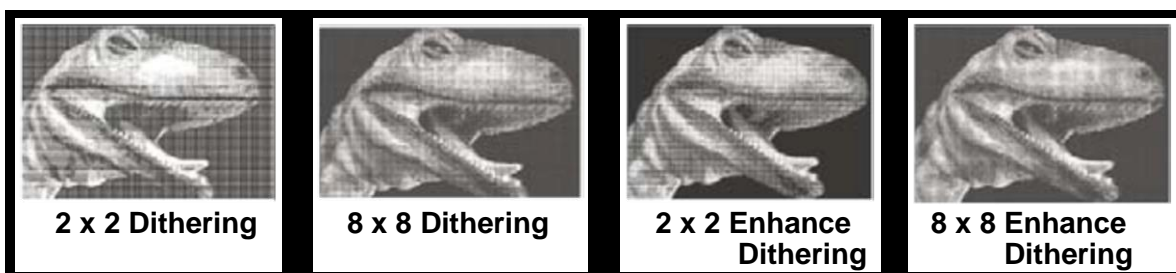

Enhance Dithering [DEFAULT SETTING: Unselected]

Selecting this will produce a finer dithering output.

- **Error Diffusion (Raster Page):** Interprets and outputs the raster engraving via the error diffusion method. This mode will allow you to select from three diffusion types: Floyd, Stucki, and Jarvis.

- **Diffusion Type: Floyd, Stucki, Jarvis** [DEFAULT SETTING: Floyd]

Each diffusion type presents the shade of image as different spread halftones instead of dots to compose a raster image.

The following diagram is an example of the raster effects when using the different diffusion types.



Tip

There is no "correct" or "best" setting when using the Raster options. The most appropriate settings will be based on a variety of factors: your design, the material you are engraving on, the results you wish to achieve, etc. Please take some time to experiment with the multitude of raster options to get the one you feel is the best for your piece. This is where much of the fun in engraving is.... experimentation!

Stamp Page

Producing stamps require different operational steps than your standard engraving or cutting jobs. The Stamp page offers dynamic options allowing you to customize your stamp production process.

NOTE

The Stamp page will only appear and be accessible when you have selected the Stamp Mode from the Options Page.



Tip

Functions located on the other pages that are useful when making a stamp: Set Shoulder, Pitch, Border, Invert, and Mirror.

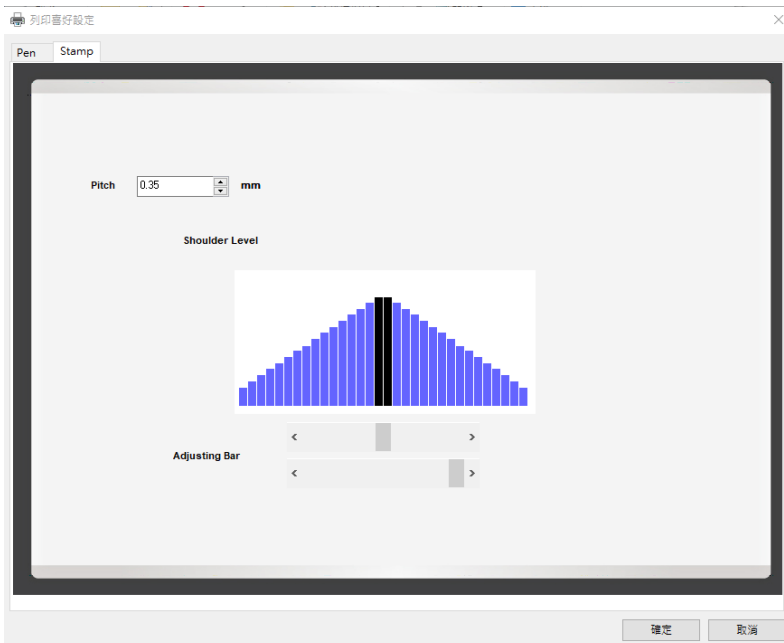

Pitch (Stamp Page)

Your stamp will be a reversed image composed of engraved depressions and ridges. Think of these ridges as the "contact sections" of the stamp. If the ridges of these contact sections are too thin, they may break. The Pitch setting allows you to increase the width of the ridge base, hence creating more stable "contact sections" and longer lasting stamp. The pitch value setting allows you to adjust the base width of the ridge. Broad pitch gives the maximum amount of support for each ridge. Experiment with different pitch value settings in order to produce the stamp that is best suited for your application.

Adjustment Bar / Power Level (Stamp Page)

Another important aspect of creating a stamp is setting the slope level of the shoulder. The shoulder is the section from the "contact section" of the stamp to its base. This function allows you to adjust the slope for the shoulder sections of your stamp. By sliding the sliders or directly input of power levels, you will be able to change the slope of the shoulder.

NOTE

The visual representations of the Pitch and Shoulder Levels in the C180II driver are an exaggerated representation to allow for easy visual guidance and precise input. Remember we are working with distances less than 1 mm here.

7.4 E200S Touch Panel Operation

7.4.1 Navigation Chart of E200S Touch Panel

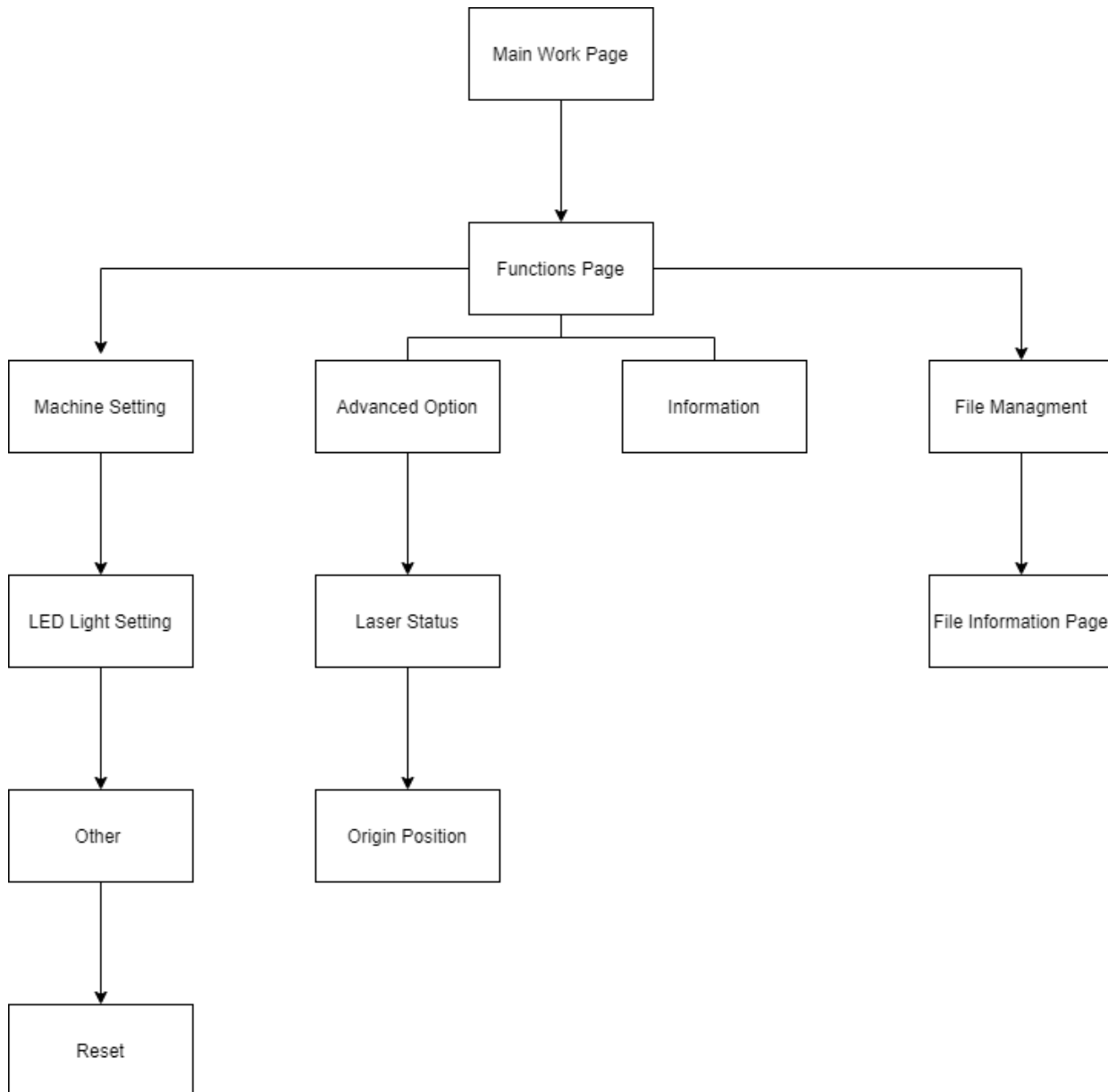

7.4.2 Main Work Page

When the LaserPro E200S is powered on, the machine will perform a series of safety checks and initializing routines. The Touch Panel screen will display the GCC copyright, LaserPro logo, and machine initialization pages before going to the main work page.

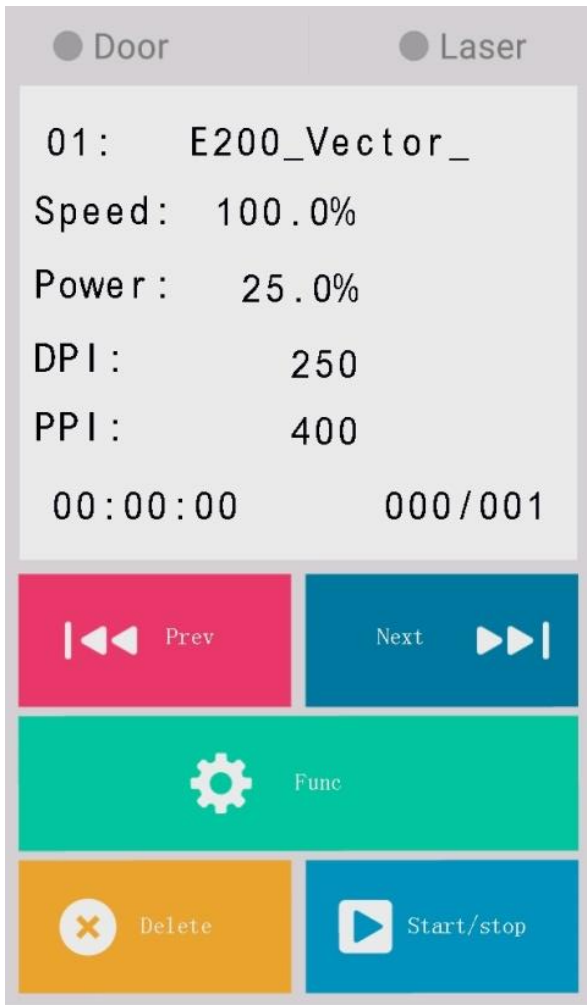

Door - The door light will illuminate when the top lid are open or improperly closed.

Laser - The laser light will illuminate when the laser is active and in operation.

Prev. -Allows you to go to the previous file.

Next - Allows you to go to the next file.

Func. - Press this button to enter the function page.

Delete - Provides quick access to delete the current job.

Start/Stop - Allows you to start or stop engraving jobs, once those jobs have been successfully loaded onto the system.

The main work page is the page that the LaserPro E200S will default to upon startup and will be the “home base” for when navigating through the various functions of the touch panel. This will be the page that is displayed when you are processing your jobs. This page contains specific job information such as the current job’s name, Speed, Power, DPI, PPI processing / remaining times, and jobs loaded.

7.4.3 Function Page

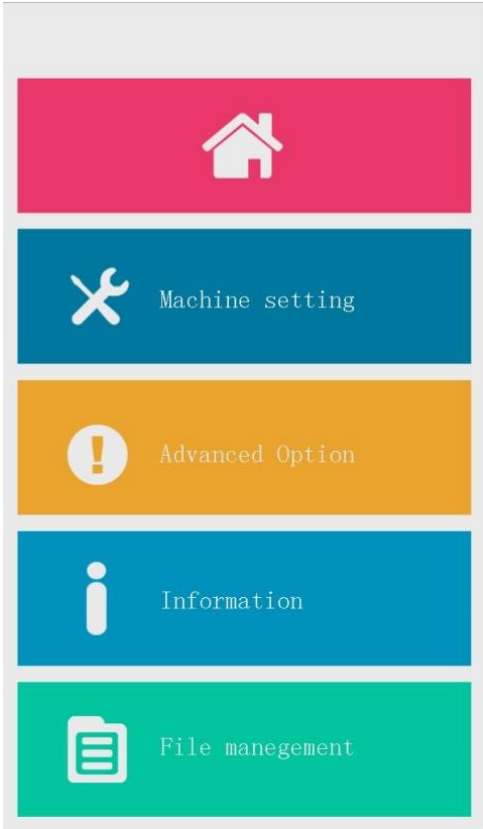

- Machine Setting Page – this page allows you to do LED light setting, reset and offset tuning.
- Advanced Option – this page allows you to view laser status and origin position.
- Information Page – this page allows you to view information regarding the system such as the GCC logo, machine name, firmware version, and other information.
- File Management Page – this page allows you to manage the files that you have loaded onto the LaserPro E200S

7.4.4 File Management Page

To manage the edited file to adjust / set up the parameters.

File Information Page

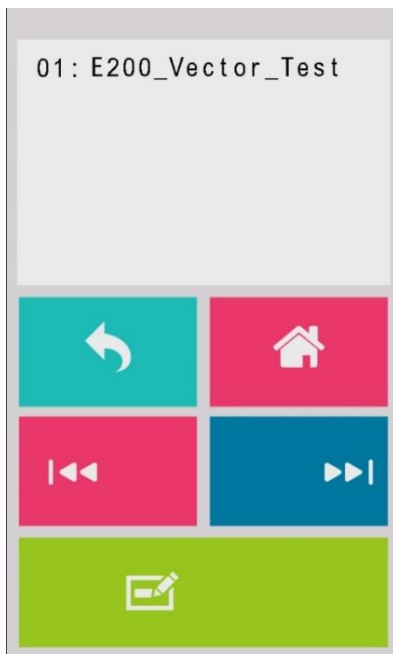

File Edit Page



7.4.5 File Management Page >> File Edit Raster Page

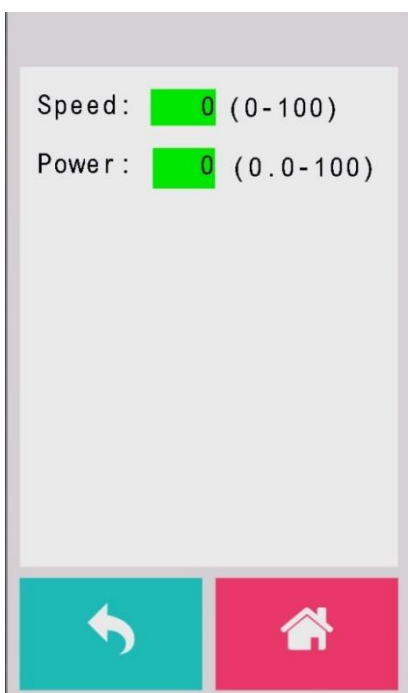

The File Edit Raster Page allows you to edit the raster power and speed settings. These settings correspond to the same settings found on the LaserPro E200S driver. This page allows you to easily adjust these values to make immediate adjustments while processing your loaded jobs, even when you have disconnected your computer from the LaserPro E200S

- Raster Power: 0.0% - 100%
- Raster Speed: 0.1% - 100%

7.4.6 File Management Page >> File Edit Vector Page

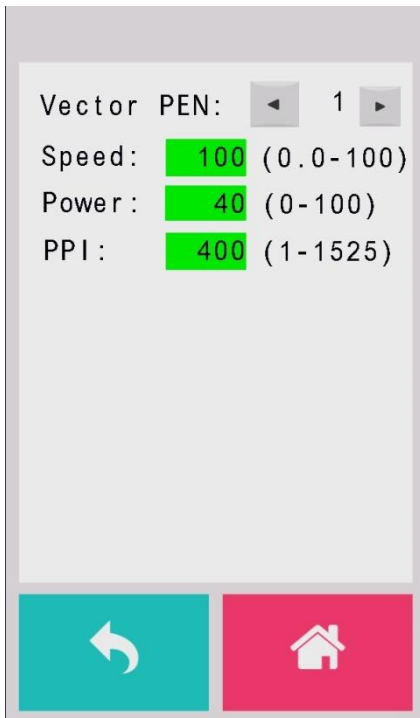

The File Edit Vector Page allows you to edit the vector pen, vector power, vector speed, and vector PPI, and power ramp settings for the selected job. These settings correspond to the same settings found on the LaserPro E200S driver. This page allows you to easily adjust these values to make immediate adjustments while processing your loaded jobs, even when you have disconnected your computer from the LaserPro E200S.

- Vector Pen: 1 - 5
- Vector Power: 0.0% - 100%
- Vector Speed: 0.0% - 100%
- Vector PPI: 30 - 1524
- Power Ramp: YES / NO

7.4.7 Machine Setting

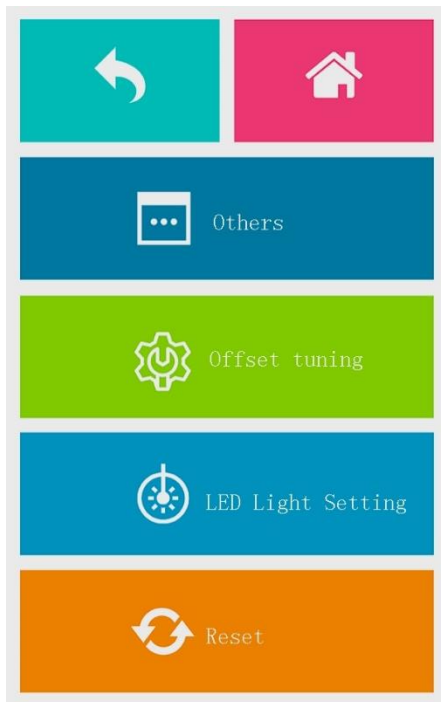

The Machine Setting Page allows you to access and modify various machine settings, including: Others (Air Delay), Offset tuning, LED light setting, Reset.

7.4.8 Other Page >> Air Delay Setting Page



The Air Delay setting allows you to specify the delay in seconds of the SmartAIR air-assist after the point of laser firing.

- Air Delay: 1-100 seconds



Tip

Depending on the material you are engraving with, your laser settings, and the desired results, please experiment with the air delay to achieve your desired results.

7.4.9 Offset Tuning

The trace file offset page allows you to adjust the offset for trace file, you can tuning the trace file by using this function.

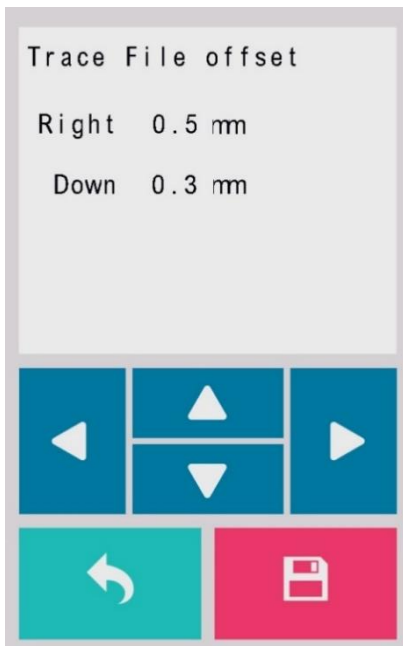

7.4.10 LED Light Setting

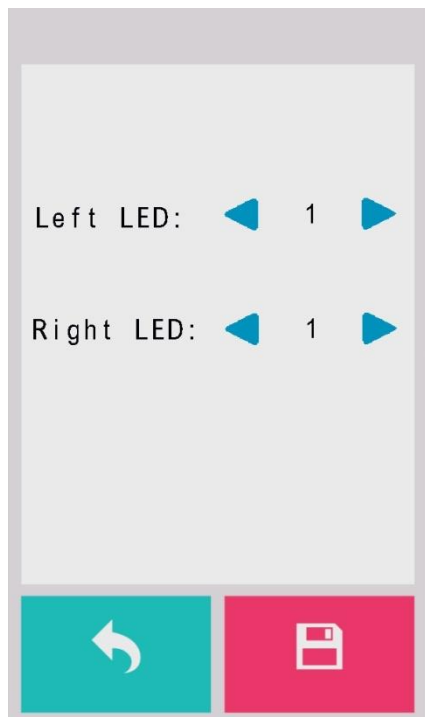

The LED setting page allows you to set the lightness of LED, level: 1~5

7.4.11 Reset Page

The Reset Page will restore machine settings back to factory default. Press ENTER to confirm the change, and restart the machine.

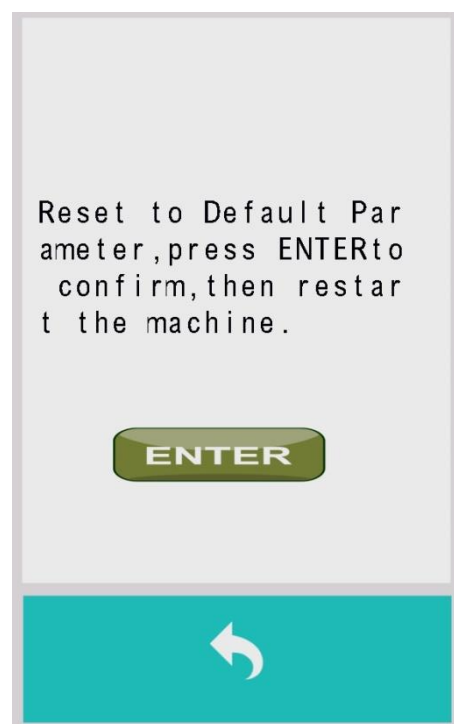
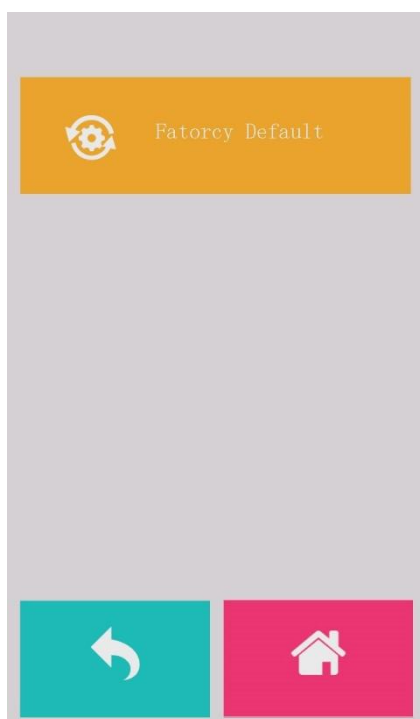

7.4.12 Machine Information Page

The Machine Information Page allows you to view information regarding the system such as the GCC logo, machine name, firmware version, and other information.



7.4.13 Advanced Option

The advanced page allows you to enable different usages for the laser machine, such as Laser Status – to reset laser firing time, Origin Position setting.

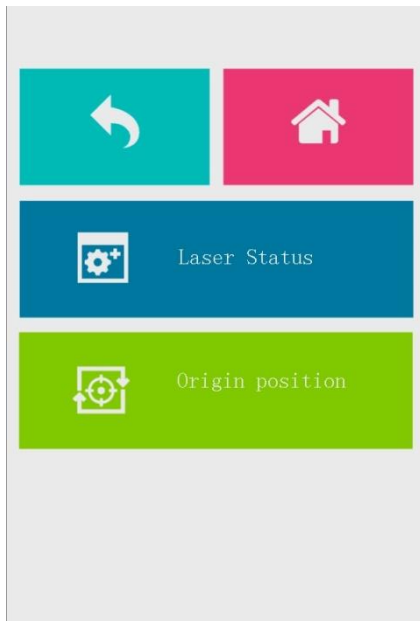

7.4.14 Advanced Option >> Laser Status

Reset Laser Firing time, you will have to enter the password to reset the Laser Fired time

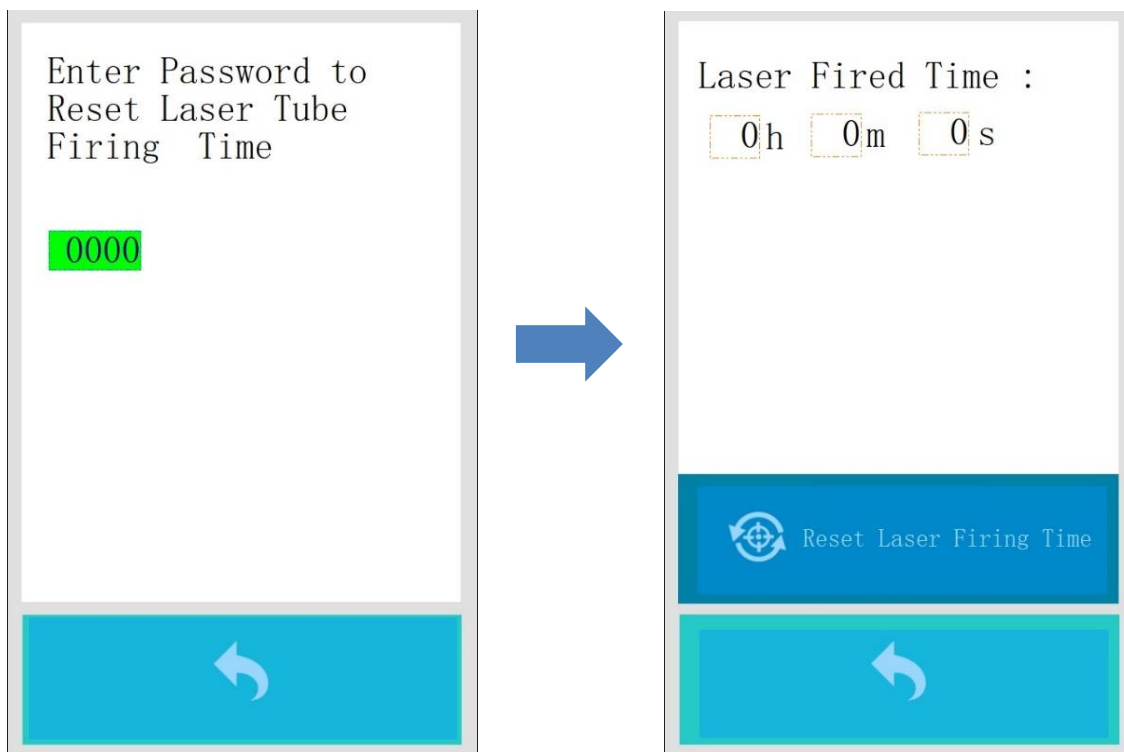

7.4.15 Advanced Option >> Origin Position

The Origin Position Page allows you to reset the origin position by defining the current X-axis and Y-axis positions. You will need to reset the origin position if you change the ruler of the working table.

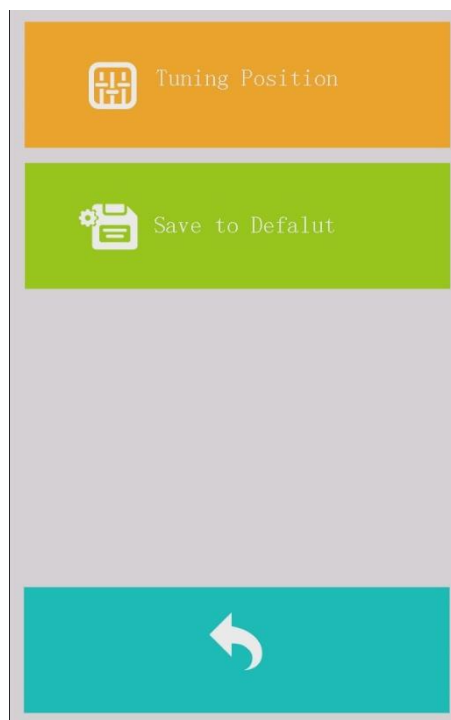

Chapter 8

Optional Items

Fume Extraction System

Air Compressor

Rotary Attachment

When purchasing the LaserPro E200S from your local authorized GCC distributor, you will be provided a chance to purchase optional items to enhance your experience with your system. If anytime after the purchase of your LaserPro E200S, would you like to purchase any optional item, please contact your local authorized GCC distributor.

8.1 Fume Extraction System Option

To properly remove dust, vaporized materials and chemical smoke from the working area and machine, it is necessary to install a suitable Fume Extraction system. The Fume Extraction system and other components are readily available from your local authorized GCC distributor or you can elect to purchase and install one yourself with compatible models found at your local industrial supply store.

LaserPro's Fume Extraction Systems are specifically designed to prevent personnel from inhaling hazardous fumes and dust generated by the laser process. Available for all LaserPro engravers, the LaserPro Fume Extraction System represents the latest in fume extraction and odor reduction technology for all types of applications. Quiet operation, high vacuum capacity, compact design and long life expectancy are but a few outstanding features. Each LaserPro Fume Extraction System is powered by a maintenance-free, continuous-running turbine. In order to ensure personnel safety and legal compliance, the LaserPro Fume Extraction System is CE-compliant. To purchase a LaserPro Fume Extraction System, contact your local authorized GCC distributor.

8.1.1 INSTALLATION (Self-Assembled Unit)

- 1) Purchase an exhaust system with 4" exhaust port at your local industrial supply store, we recommend you to have a contractor install the exhaust system if a centralized exhaust system is preferred. We highly recommend you to use movable exhaust systems with filter systems.
- 2) Mount the exhaust system in an obvious and accessible location, not too far from the E200S, so it can be routinely switched on prior to laser engraving. The maximal distance you should mount the exhaust system away from the E200S depends on the blower's vacuum capacity. We recommend you consult with the vendor regarding the unit's vacuum force, maximal distances, based on the available models.
- 3) There is a 4" odor reduction tubing adaptor that comes with E200S machine which is the accessory box. Connect the 4" diameter adaptor to the ventilation opening located on the rear side of GCC E200S machine. (As shown in the picture below).

Try to keep this tubing as straight as possible as bends reduce the exhaust efficiency. Use the appropriate sized tube clamps and sealants to ensure a tight and secure attachment.

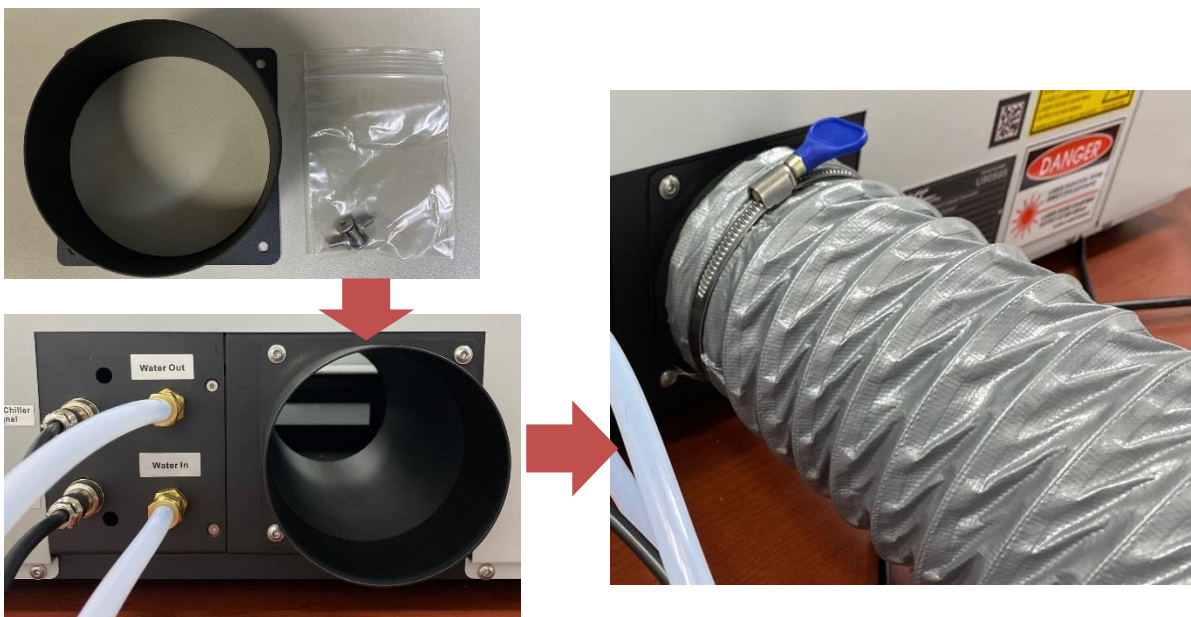

8.2 Air Compressor Option

Specifically designed for laser engravers, the air compressor utilizes an oil-free diaphragm. The air compressor helps eliminate harmful and potentially damaging moisture from the laser optics, maximizing laser optic life. In addition the air compressor provides the optimal air flow to the SmartAIR nozzles to minimize flaming, suppress working temperatures, and blow away dust and particle byproducts generated from the laser process.

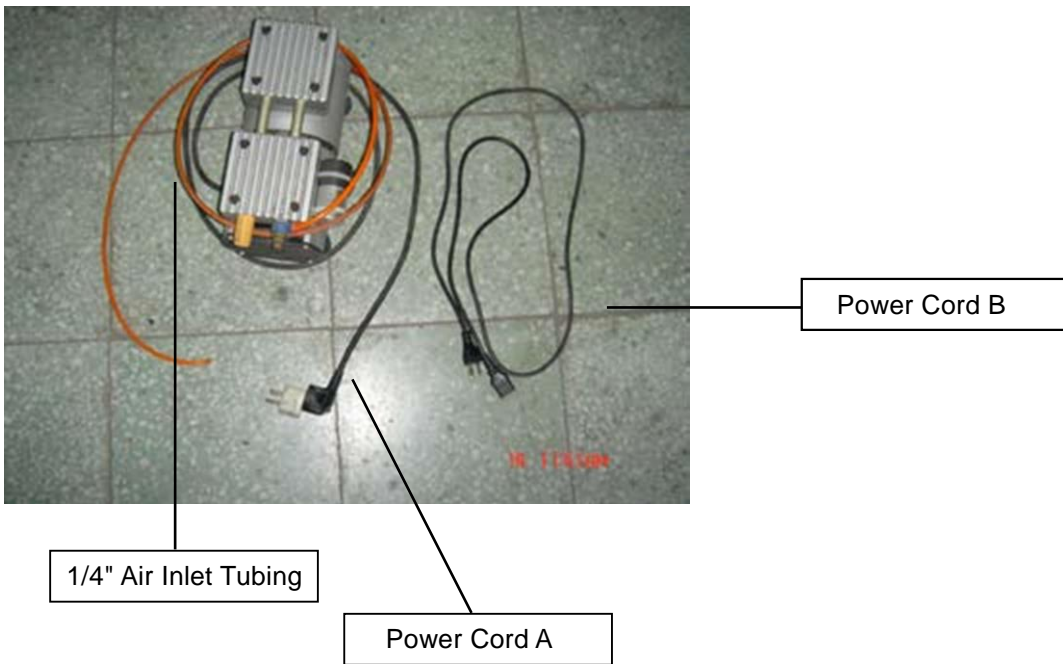

INSTALLATION:

- 1) Remove the plugs on the air compressor to expose the air inlets.
- 2) Fasten the included air tube fastener valve to the outgoing air inlet (indicated by 2a) and the air filter into the ingoing air inlet (indicated by 2b).

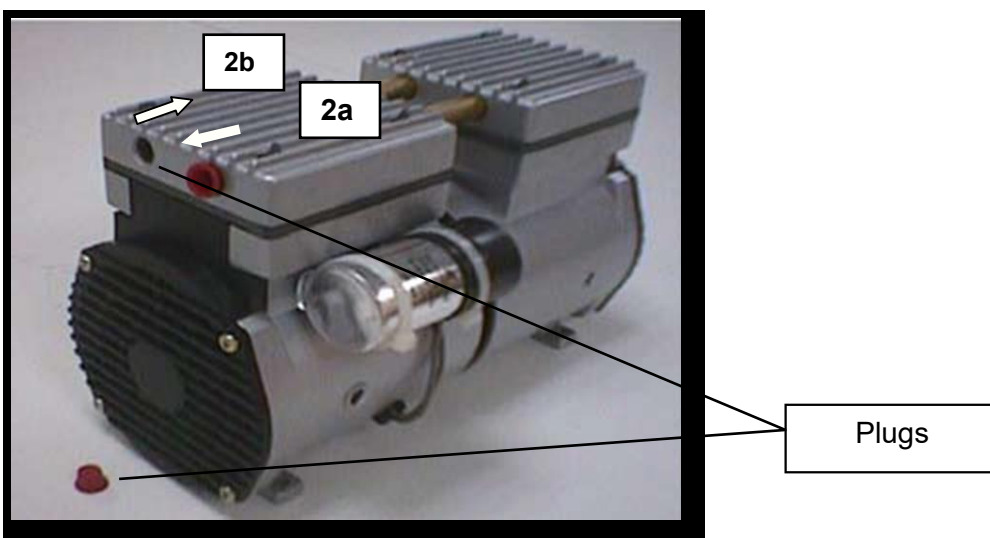

- 3) Connect a ¼" tubing to the air tube fastener valve on the air compressor.

NOTE

It is important that the ¼" air tubing has clean, straight cuts on each end. Jagged or slanted cuts will not produce adequate sealing capabilities.

- 4) Take the unattached end of the ¼" air tubing (other end already connected to air compressor) and connect it to the air tube connector on the air assist valve. Make sure you press down on the air tube fastener when inserting the ¼" air tubing, to form a tight, secure attachment as indicated in the diagram below.

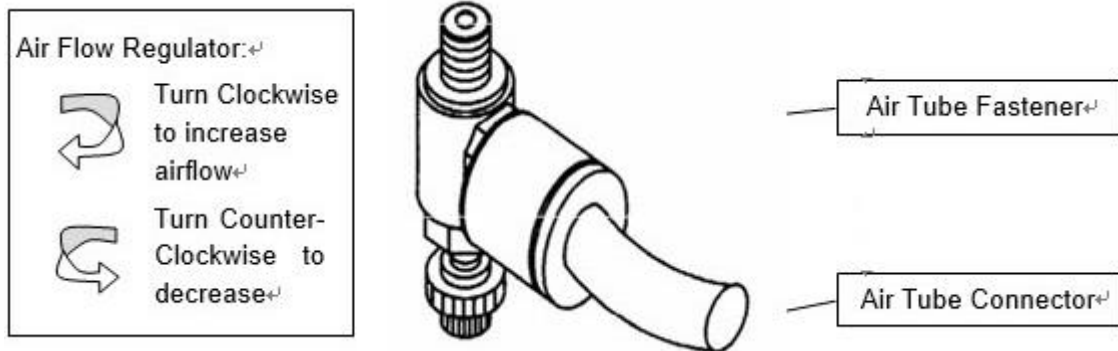

- 5) Both the Air-Assist Valve and AC Power Sockets are located on the rear side of laser system.



- 6) Plug the air compressor's power cord A into the AC internal power socket.
- 7) Plug the female end of power cord B to the AC power socket on laser system and the male end to an external power outlet.

Congratulations, you have finished setting up the air compressor. Make sure you have the proper SmartAIR nozzle installed (depending on your application), before you turn on and utilize the air compressor.

OPERATION:

Switch on the air compressor unit and make sure that the airflow regulator on the air assist valve is opened (turn clockwise to increase the airflow, counter-clockwise to decrease the airflow). The air nozzle under the laser head should emit a steady flow of air.

With the SmartAIR nozzle and air compressor properly installed and operating, all configurations and settings relating to air-assist functions are controlled through the LaserPro print driver and hardware control panel. Please refer to the LaserPro E200S PEN page on print driver section of this manual for details on how to enable and configure air-assist functionality.

8.3 Rotary Attachment Option

The rotary attachment option provides the E200S with the ability to engrave on cylindrical or spherical objects. In addition to the standard X, Y, Z axis, the rotary attachment allows for a fourth axis which rotates your object 360° to allow for engraving on cups, wine glasses, and even spherical objects.

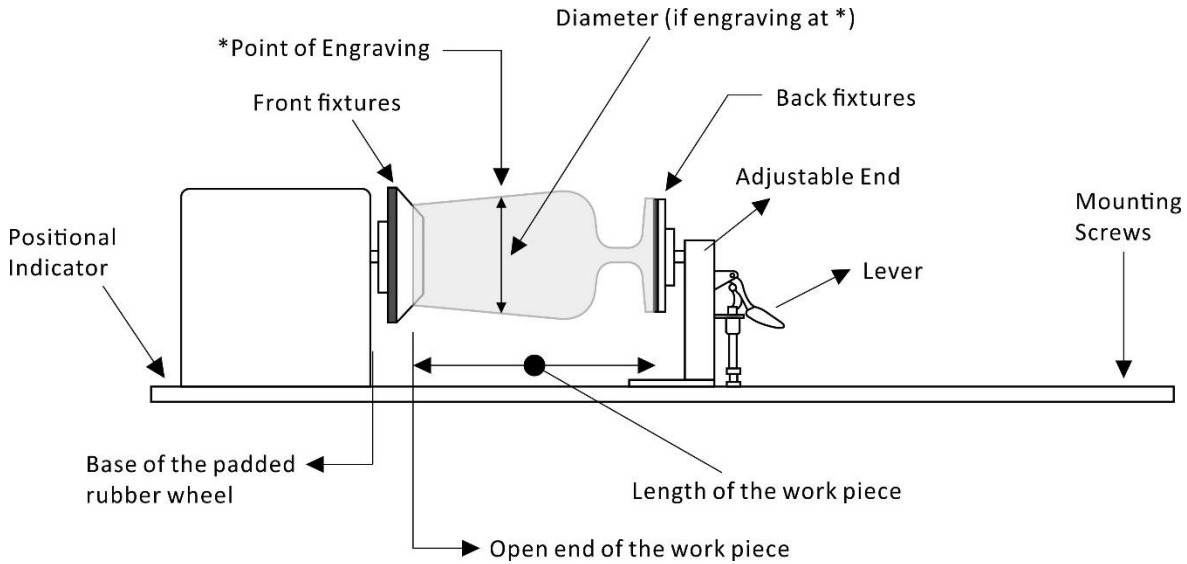

Work Piece Limitations	
Maximum Length	250 mm (10 inches)
Maximum Loading Weight	3kg (6 lbs.)
Min. Diameter (upper axle center)	5mm (0.2 inches)
Max. Diameter (upper axle center)	50mm (2inches)
Min. Diameter (lower axle center)	50mm (2 inches)
Max. Diameter (lower axle center)	70mm (3 inches)

- GCC design two axle-center for E200S rotary attachment to enlarge the availability object sizes.

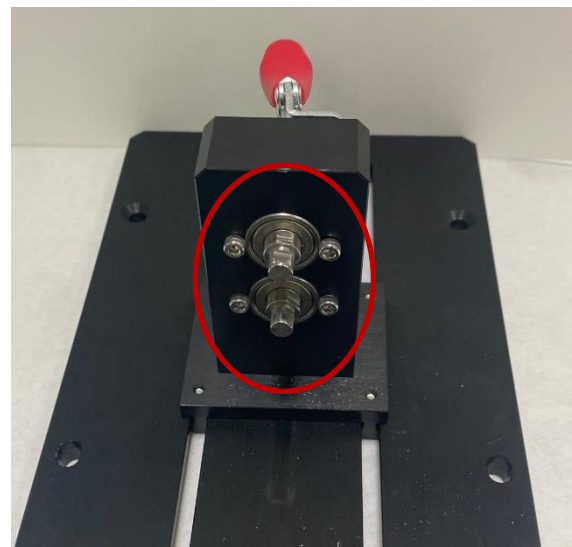

Follow the procedure to exchange the front fixture and back fixture:

- 1) Remove the two screws holding the fixtures.

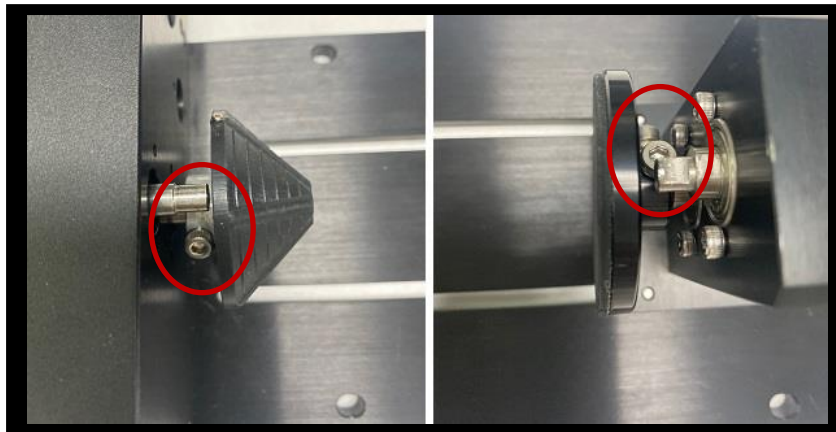

- 2) Exchange the front fixture and back fixture as below picture,

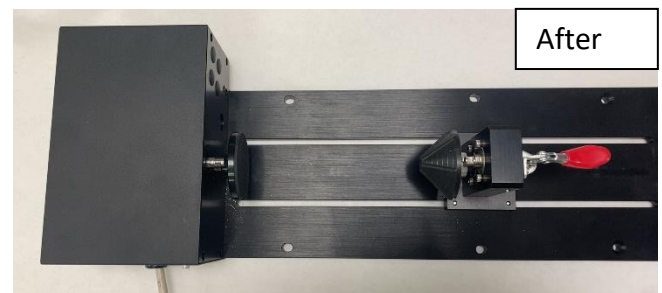
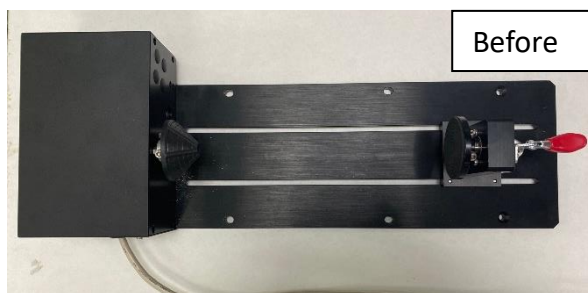

NOTE

Align the origin point to the flat top of shaft then tighten the first screw against it, following to tighten the second screw.

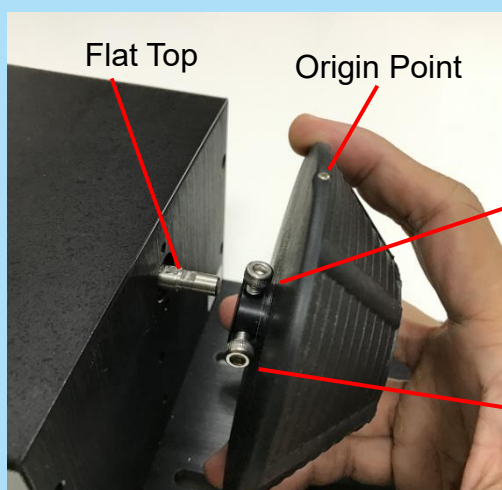

1. Align the origin to flat shaft, then tighten this screw against it
2. Following to tighten the second screw

INSTALLATION:

a. Uninstall the grid cutting table

1) Remove the four screws from the grid cutting table.

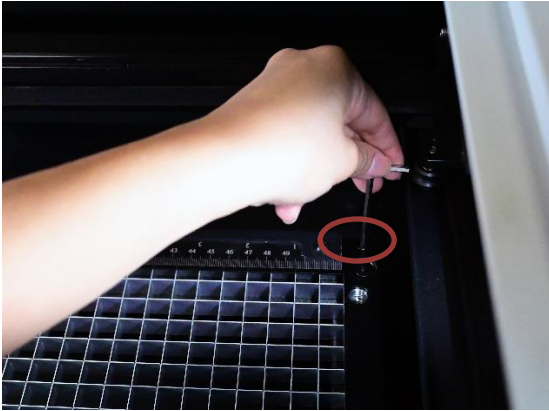

NOTE: There are four hand screws to be removed.

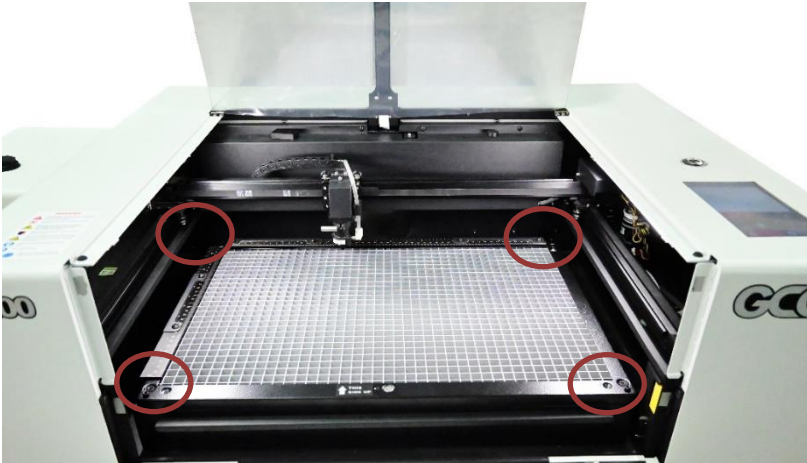

2) Take out the grid cutting table as shown below



3) E200S - Grid cutting table uninstallation is completed.

b. Installation of E200S Rotary Attachment

- 1) Turn off the power of the laser engraver
- 2) Open the front panel of the machine, lower the working platform to its bottom
- 3) When placing the rotary attachment on the working table, the rotary attachment can only apply the small conical fixtures to work with small objects of diameters.
- 4) If working with bigger objects are required, remove the working table by releasing the four thumbscrews towards the sides and place the rotary attachment on the bottom tray. Under this condition, Rotary Attachment can use either the small or large conical fixtures
- 5) Line up the rotary attachment to the left hand side of the working area and towards the mid-section of the working area.
- 6) Connect the rotary attachment cable to the rotary attachment port located inside the machine (shown in the picture below)
- 7) Close the front door panel.
- 8) The rotary attachment is now properly installed.
- 9) Power on the LaserPro E200S and the rotary attachment will be automatically detected and the engraving table will automatically move to its lowest position.



Rotary Attachment Port

OPERATION:

- 1) Use a ruler to measure the diameter (at the point on the work piece you will be engraving) and length of the work piece you will be engraving. Make a record of this.
- 2) Load the work piece onto the rotary attachment
 - a) First lift the rear-end lever of the rotary attachment to release the adjustable end of rotary attachment.
 - b) Load the work piece by centering its open end against the front fixture and slide the adjustable end to fit the bottom of work piece firmly.
 - c) Lower down the lever to secure the work piece with the rotary attachment.
- 3) Manually move the laser carriage to the proper X/ Y location on the work object where you will do laser engraving or cutting. Hit the Auto Focus button on control panel and the laser machine will now properly focus at the location to be laser engraved or cut.



CAUTION

If your work piece is small, please apply 4" focal lens for operation to prevent the lens carriage from colliding with the rotary attachment.

- 4) Prepare the graphic you would like to engrave with the rotary attachment, and print it to GCC laser print driver, and go to "Paper" page of the Print Driver.
- 5) At the Paper Page, the first thing is to check the "Rotary Fixture" option. The Paper Size and Rotary Parameter will change to allow for proper input based on the rotary attachment setup.
- 6) Under Paper Size column, the X value represents the length of the work piece. Enter the length of your work piece in this field
 - a) Under Paper Size column, the Diameter value represents the diameter of the work piece (at the position where to be engraved). Enter the diameter of the work piece in this field. Again remember the proper diameter value would be measured at the location where laser is going to do engraving.
 - b) Under Rotary Parameter column, the Offset value represents the distance from machine default origin to where you would like to start laser job. The default offset value is zero.

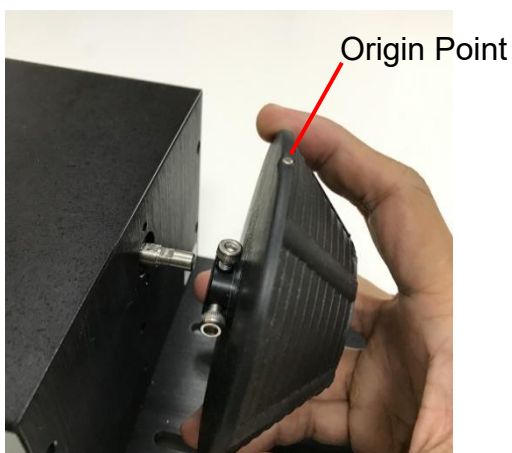

Please make sure the red beam is pointed to the "Origin Point" as below picture.

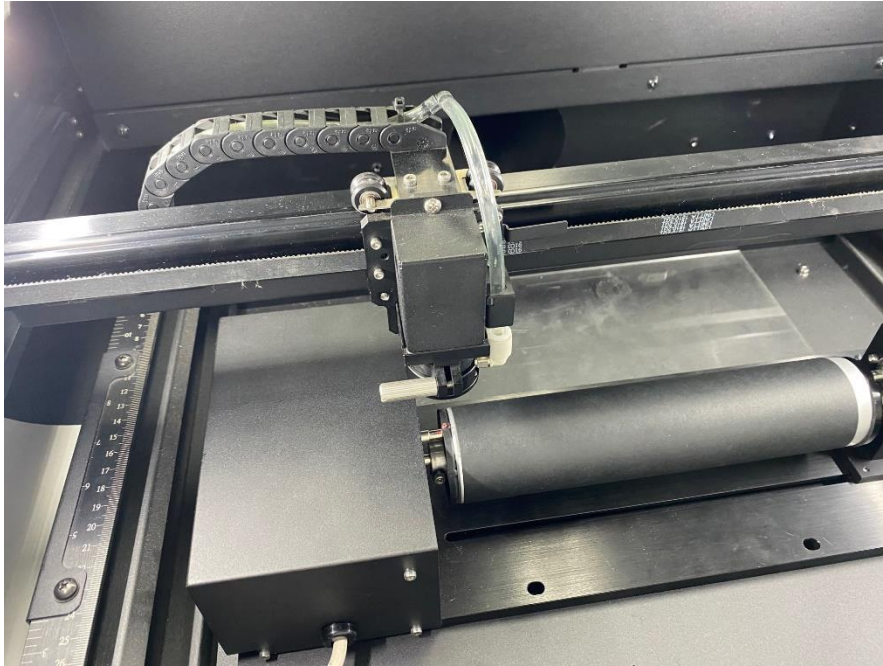

7) Go back to other pages of GCC Laser Print Driver to set up laser parameters like speed, power, and dpi etc. (refer to Chapter V of user manual for print driver operation details) and click “OK” to print your design to the laser machine.

8) Despite the dummy-proof installation design, please ensure that the rotary device is installed correctly before turning on the machine

Chapter **9**

Basic Maintenance

Suggested Cleaning and Maintenance Supplies

Maintaining the Work table and Motion System

Cleaning the Optics System



Keeping your LaserPro E200S clean and well maintained will ensure quality output, consistent reliability, and extended product life. Smoke, dust or residue build-up inside the laser system or the mechanical components can cause a reduction in the laser power, irregularities in the motion system, reduced product life cycle, and a host of other avoidable problems. This section will cover how to perform regular maintenance on the LaserPro E200S's worktable, motion system, mirrors, and focal lens.

The frequency of the cleaning schedule will depend on number of variables such as the types of material you work with, the immediate work environment, the frequency of use, the quality of the exhaust system, etc. Clean the machine on weekly base for normal case.

WARNING
<ul style="list-style-type: none"> ▪ Electrical shock may occur if you do not turn off and unplug the E200S before cleaning. ▪ Damage may occur to the system if you do not turn off and unplug the E200S before cleaning. ▪ Always turn off and unplug the LaserPro E200S before cleaning! ▪ Resulting debris from laser cutting are very dangerous and may cause fire hazard.

9.1 Suggested Cleaning and Maintenance Supplies

Cleaning / Maintenance Tool	Special notes
Soap Solution or All-Purpose Cleaner	
Paper Towels	
Cotton Cloth	
Denatured Alcohol	DO NOT use alcohol on any painted surface, plastic, or the laser system!
Acetone	ONLY to be used on the working table
Vacuum Cleaner with a Flexible Nozzle	Only to be used in and around the worktable and motion system
Light Grade Machine Oil	Supplied
Cotton Swabs	Supplied
Lens Cleaner	1pc Supplied; suggest source locally*
Lint Free Lens Tissue	Supplied
# 2 Phillips Screwdriver	
Allen Wrench .050"	

*The recommended lens cleaner is Eclipse Cleaning System Solution from Photographic Solutions or HPLC grade Methanol. Search “Eclipse Cleaning System Solution” on Amazon or eBay to get the solution locally.

<http://www.amazon.com/Photographic-Solutions-ECDCS-Cleaning-Solution/dp/B0000AUR11>



Eclipse Cleaning System Solution

9.2 Maintaining the Worktable and Motion System

9.2.1 Cleaning the Worktable and Motion System

Clean the working table and the motion system on weekly basis through the following steps:

- 1) Turn the power off and unplug the E200S before cleaning.
- 2) Use a vacuum cleaner with a flexible nozzle to remove dust and debris from the worktable and motion system.
- 3) Apply small amounts of all-purpose cleaner, alcohol, or acetone to a paper or cotton towel to clean the working table.
- 4) Apply a soap solution, all-purpose cleaner, or alcohol to a paper or cotton towel to wipe down the rails of the motion system.
- 5) Wait for all cleaning residue to dry completely before plugging in and operating the E200S.

CAUTION

- Never pour or spray alcohol or acetone directly to the working table.
- Oil, alcohol and acetone can cause fires or smoke build-up if improperly used.



TIP
Please clean the AutoFocus pin each time after completing the engraved job to make sure the AutoFocus pin is free to move.

9.2.2 Lubrication of the X / Y Rails

In order to keep the motion system running smoothly, the X / Y rails of the motion system will need lubrication on a weekly basis. Use a small amount of light grade machine oil or PS2 grease to a paper or cotton towel and apply to the rails.

You can purchase PS2 grease from NSK dealers worldwide. Please visit <http://www.nsk.com> for additional information.

NOTE

- Always clean and lubricate the rails after working with materials that produce lots of debris (such as wood).
- Too much oil or PS2 grease applied to the X / Y rails will accelerate the build up of debris.

9.3 Cleaning the Optics System

9.3.1 Cleaning the Mirrors

After you have removed each mirror, you will want to inspect each mirror for scratches, smoke residue, or debris. If any residue or debris is present, use the following steps to clean the mirror.

- 1) Hold the mirror with the reflective side up, without touching the reflective side of the mirror (DO NOT apply any finger pressure or any other cleaning solutions to the mirror surface).
- 2) Drape a new sheet of lens tissue over the mirror.
- 3) Apply a few drops of lens cleaner on the tissue covered mirror (apply enough so that the tissue absorbs just enough to cover the mirror surface).
- 4) Pull the tissue across the mirror in only one direction.
- 5) Repeat the cleaning processes if the mirror is not completely clean after the first attempt.
- 6) Make sure that the mirror is completely dry before reinstalling it.



CAUTION

If the center of the mirror is scratched, contact your LaserPro E200S dealer for a replacement.

9.3.3 Removing and Cleaning the Focal Lens

- 1) Remove the nozzle from the E200S carriage.

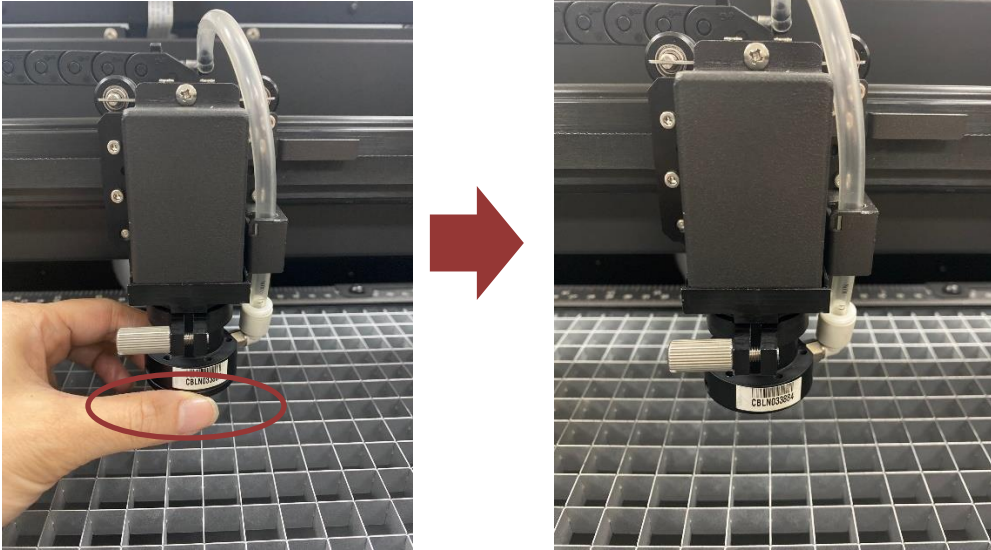

- 2) Remove the tube by releasing the hand screw.

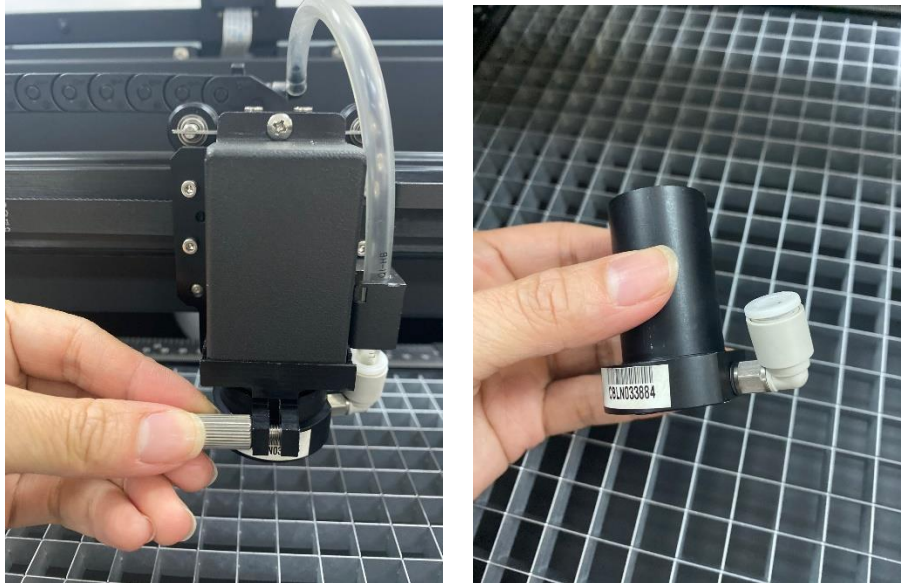

- 3) Carefully pull out the focal lens.



- 4) Clean the focal lens with a cotton swab and lens cleaner solution. Be sure to clean both sides of the focal lens (DO NOT apply any pressure or other cleaning solutions to the lens surface).
- 5) After cleaning, use a cotton swab to gently dry the focal lens and lens cover.

Chapter 10

Appendix

GCC LaserPro E200S Specification Sheet



10.1 GCC LaserPro E200S Specification sheet

LaserPro E200S	
Work Area	20 x 12.9in. (510 x 330mm)
Maximum Part Size (WxLxH)	20.4 x 13.4 x 0.78in.(520 x 340 x 20 mm) (with grid cutting table)
	19.8 x 13.4 x 2.99in.(505 x 340 x 76 mm) (remove grid cutting table)
CCD Camera	Standard, accurate within 0.16in (4mm)
Working table	Standard grid cutting table
Dimensions	36 x 30.7 x 11.8 in. (915 x 780 x 300mm)
Laser Source	40W Sealed CO2 Laser
Drive	Closed-loop DC Servo Control
Maximum Working Speed	20 IPS
Maximum Cutting Thickness	10mm
Speed Control	Adjustable from 0.1~100% (Up to 5 color-linked speed settings per job)
Power Control	Adjustable from 0~100% (Up to 5 color-linked power settings per job)
DPI	Available 250,380,500,760,1000
Focus Lens	Standard 1.5"
Computer interface	Full-speed USB 2.0 port, 10 Base-T Ethernet
Compatible Operating systems	MS Windows
Control Panel	7" touch screen
Connection	WiFi, Ethernet, USB
Water Chiller	Standard
Safety	Class I Laser Product Complies with EN60825-1 Class II Laser Product Complies with CDRH
Facility Requirements	
Electrical	100-240VAC, 50-60Hz Auto Switching, Max. 15A
Air Exhaust System	External exhaust system with minimum flow rate 300 m3/h (10594 ft3/h) is required, 2,500PA negative pressure (PURE-AIR PA-300 @ 4" exhaust port)

* Speed does not equal to throughput. See dealer or visit www.GCCworld.com for more details.

* Specifications are subject to change without prior notice.

* Caution—Use of controls or adjustments or performance of procedures other than those specified herein may result in hazardous radiation exposure.